

The Proper Tools To
Keep Your Equipment
MOVING



TIRE SERVICE EQUIPMENT
AND ACCESSORIES



1.800.352.9852

www.esco.net



AUTOMOTIVE



HEAVY DUTY TRUCK



AGRICULTURAL

ABOUT ESCO

ESCO is the world leader in manufacturing and supplying quality tire service equipment for the automotive, agricultural, commercial truck, off-the-road (OTR), and mining markets. ESCO produces a wide range of tire service/handling products ranging from: heavy duty bead breakers; hydraulic rams; air hydraulic pumps; heavy duty jacks and stands; tire demounting and mounting tools; tire wheel dollies, torque wrenches, and many other quality tire service equipment to better aid in safely and efficiently servicing tire/wheels.

ESCO also has an in-house hydraulic repair facility where we feature our 24-hour Turnaround Hydraulic Tool Repair Program. ESCO is known in the industry as the expert in producing equipment for servicing single and multi-piece rims, with over 30 years of experience, ESCO has the Proper Tools to Keep All of Your Equipment Moving.



Table of Contents:

Air Bladder Jacks.....	73
Air Operated Lifting Bags & Accessories.....	67
Balancing Compounds.....	63
Bead Breakers.....	8
Bottle Jacks.....	81
Forklift Jacks.....	80
HD Air/Hydraulic Jacks.....	82
Heavy Duty Transmission Jack.....	80
Heavy Duty Wheel Dolly.....	72
High Tonnage Jacks and Accessories.....	24
Hydraulic Equipment Accessories.....	23
Hydraulic Pumps.....	17
Hydraulics Rams & Cylinders.....	20
Jack Stands.....	87
Liquid Transfer Pump & Accessories.....	65
Mobile Lifting System.....	78
OEM/OTR Tire & Wheel Accessories.....	68



MOBILE SERVICE TRUCKS



OFF-THE-ROAD



MINING

OUR MISSION

To supply innovative industry evolving tire tools and equipment to the marketplace through expanding relationships with our distribution channels.

OUR VISION

We envision ourselves changing the way tire service professionals handle tires/wheels globally through the use of innovation, market research, consumer knowledge, and industry trends to better supply relevant products that will continue to support safety and efficiency.



For more information about ESCO visit www.esco.net/about or Scan the QR code.

The Proper Tools To
Keep Your Equipment
MOVING

Rim Rust & Tire Coolant.....	66
Support Plates & Cribbing.....	31
Tire Demount & Mounting Equipment.....	43
Tire Inflation Equipment.....	35
Tire Spreaders.....	61
Tire Tools & Accessories.....	53
Tire Wheel Dollies.....	57
Torque Tools & Accessories.....	48
Trolley Style "Floor Service Jacks".....	75
Truck Tire/Wheel Service Equipment.....	59
Wheel Guards.....	58
<i>YAK Line Application Guide.....</i>	<i>91</i>
<i>Balancing Beads Application Chart.....</i>	<i>92</i>
<i>Bead Breaker Pump Guide.....</i>	<i>93</i>
<i>Bead Breaker Application Guide.....</i>	<i>94</i>
<i>Parts & Accessories.....</i>	<i>95</i>
<i>Repair & Warranty Program.....</i>	<i>97</i>

ESCO HOME ON THE WEB

Videos • Instructions • Sales Flyers • Product Info • Repair • and much more...

ESCO's home on the Web can be found at www.esco.net. Designed as a sales tool, the ESCO site is a great way to stay connected with all of the available ESCO products & services.

Visit the ESCO website for information about products, video demonstrations, product instructions/breakdowns, announcements, product registration, repair, and much more!



SCAN TO VISIT WEBSITE
OR VISIT
WWW.ESCO.NET



ESCO QR CODES

Point. Scan. Explore.

In order to give access to all of the possible sales tools available, We have included QR Codes wherever available through out the catalog!

WHAT IS A QR CODE?

A QR Code is a scannable code that has been generated to support video files, documents, images, and more. Just download onto your smart device a "QR Scanner". Great for out in the field when show products to new customers!

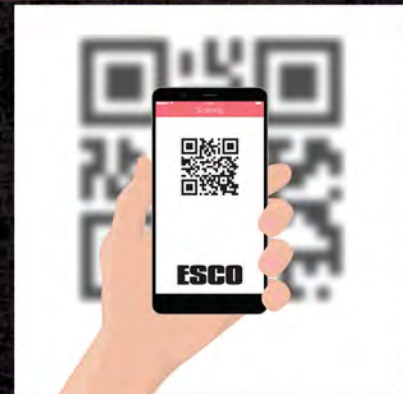

CONNECT WITH ESCO SOCIALLY

Stay Connected with ESCO Socially! ESCO is now on all of the popular social media sites such as; Facebook, Twitter, LinkedIn, Google Plus, and Much More!

Stay Connected with ESCO to get New Product News, Tradeshow Events, Specials, and More!



- facebook.com/escoequipmentsupply



- youtube.com/user/EquipmentSupplyCo



- twitter.com/escoequip



- linkedin.com/company/esco-equipment-supply-company/



ESCO

Taking care of your equipment needs since 1984...



SERVICE - Because it's not just the sale that matters...

We always maintain quality service after the sale on all of our products because the sale does not end after the product has been sold. ESCO stocks a vast amount of spare parts and has a prompt quality customer support team that will readily assist customers whenever there is a question or need.

We also have our own in house repair shop to help support service after the sale for our products and many of our competitors products.

QUALITY - Products that we can stand behind...

What keeps customers coming back to the ESCO brand is the attention to detail and quality put into each product from ESCO. We continue to manufacture and supply quality professional lines of tools and equipment that we stand behind 100%.

At ESCO, quality and field control testing are a standard. This attention to detail and quality is what sets ESCO apart from the competition, as a leader in quality and design.

WAREHOUSE - Keeping You Competitive...

We stock well over 700 Products and Parts in the ESCO line out of our master warehouse in Brooksville, Florida. Our 16,000 sq.ft. warehouse is always fully stocked and ready to ship with an average 99% Fulfillment Rate (Excluding Special Build to Order Items).

We pride ourselves in having, "The Proper Tools To Keep Your Equipment Moving", when you and your customers need them.

INNOVATION - Always Adapting and Changing...

Since 1984, ESCO has been known globally as a leader in the tire and wheel market for innovative tools and equipment to more safely and efficiently service various tire/wheel combinations. Still to this day, we continue to create and research new innovations in these tools to better help move the tire/wheel market forward.

It is our mission to always strive to design and bring safe quality equipment and tools into the tire/wheel market for many years to come and to continue to evolve and adapt as the market changes.

BRANDS & PRODUCT LINES:

ESCO



HEAVYWEIGHT



LIFTER SERIES



**MAMMUT
EZ BUSTER**



Being a long-standing member of the TIA association, ESCO is proud to provide the TIA Tire Service Training Program.

In efforts to better aid tire service professionals in the proper usage and application of tire service equipment, as well as OSHA related safety, ESCO Provides the Following Training Programs:

TIA Earthmover Tire Service Training Program



MODEL 10000-E

- ▶ DVD Course
- ▶ Includes Training Materials & Mail-in Test!
- ▶ OSHA regulation testing.

TIA Agricultural Tire Service Training Program



MODEL 10000-F

- ▶ DVD Course
- ▶ Includes Training Materials & Mail-in Test!
- ▶ OSHA regulation testing.

TIA Commercial Tire Service Training Program



MODEL 10000-C

- ▶ DVD Course
- ▶ Includes Training Materials & Mail-in Test!
- ▶ OSHA regulation testing.

OSHA
Occupational Safety & Health Administration

MSHA
Mine Safety & Health Administration

ESCO products are designed to help tire service professionals comply with OSHA & MSHA standards in the tire wheel service industry.

Look throughout the ESCO Product catalog for these related products.

IMPORTANT WARNING:

These Products as well as all tire tools, should never be used by persons unless they have been properly trained according to O.S.H.A Regulation #29CFR1910.177 entitled "Servicing Single-Piece and Multi-Piece Rim Wheels."

TIRE BEAD BREAKING - *It's All About Rims...*

ESCO Bead Breakers have become a staple in the tire service industry for well over 30 years. ESCO provides a wide range of bead breakers that can handle rim sizes from the smallest to largest of application. Here are some examples of Rim Styles & the type of Vehicles they can be found on.

Full Bead Breaker Application Guide SEE PAGE 94

STYLES OF RIMS:

Single Piece Rim



The Most common rim in the Over-the-Road Category.

Some Include:

Backhoes, Small Construction Equipment, Aerial Platforms, Compact Trailers, Recreational & ATV, Lawn & Garden Equipment, Small Wheel Loaders, Hub Wheels, Sprocketed Hub Drive Wheels, Trailers, Skid Steer Loaders, and More...

Two Piece Rim

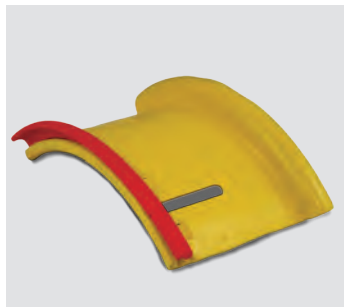

Two Piece Rims are not as common however, ESCO products can be used on any combination of rim/wheel assemblies. Pieces Include Front Flange & Rim Base.

Some Include:

Industrial Forklifts, Demountable Rims & Components Used on Heavy Trucks, Military Trucks & Trailers, Two Piece Bolt Together Style Rims, Utility Vehicles, Ground Support Equipment, and More...

Three Piece Rim

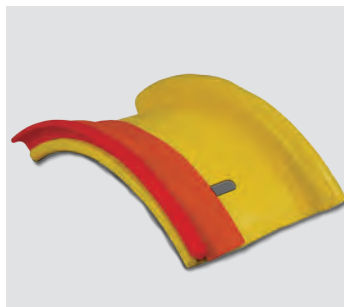

Three Piece Rims are the most common in off-the-road, agricultural, & mining applications. Pieces include Locking Ring, Rim Base, & Front Flange.

Some Include:

Construction Equipment, Telehandlers, Wheel Loaders & Graders, Articulate Haulers, Military Trucks & Trailers, Surface, Underground Mining Equipment, and More...

Five Piece Rim



Five Piece Rims are specific to mining & are most commonly large tire specific. Pieces include Locking Ring, Bead Seat Band, Front Flange, Rim Base, & Back Flange.

Some Include:

Haul Trucks, Mining Vehicles, Articulating Haulers, Wheel Loaders, Rubber Tired Dozers, and More...

Combi Bead Breaker - For Single, Two, & Three Piece Tires/Rims

Model #10101

Point.Scan.Explore.



- 1 Clamping Jaw
- 2 Redesigned Replaceable Pushing Foot
- 3 Replaceable Teeth
- 4 13.8 Tons of Bead Breaking Force - 3.75" Stroke | 95mm

- ▶ Works on single, two and three-piece truck tires/rims, including some new style wheels.
- ▶ Breaks beads in seconds using 13.8 tons of force.
- ▶ The "Combi" Bead Breaker will not work on five piece Earthmover giant wheel/rim. #10100 or the #10105 is required.
- ▶ Weight 36 lbs. | 16 kg

OSHA

"Combi" to "Maxi" Style Breaker Conversion Kit

Model #10620



- ▶ Converts Combi Bead Breaker (Model 10101) to Maxi Bead Breaker (Model 10102)
- ▶ Kit includes longer feet and claw for deep dished style wheels.
- ▶ Weight: 10 lbs. | 4.5 kg

MODEL 10202

- 10101 - "Combi" Bead Breaker Tool
- 10592 - Pump, Air Hydraulic, 5 Quart
- 10604 - Hose assembly with Hose Coupler, 8'
- 10601K - Air Reducer, 6" Whip-Hose

MODEL 10201

- 10101 - "Combi" Bead Breaker Tool
- 10590 - Pump, Air Hydraulic, 2 1/2 Quart
- 10604 - Hose Assembly with Hose Coupler, 8'
- 10601K - Air Reducer, 6" Whip-Hose

MODEL 10200

- 10101 - "Combi" Bead Breaker Tool
- 10500 - Turbo II Pump, Air Hydraulic, 3 1/2 Quart +
- 10604 - Hose Assembly with Hose Coupler, 8'
- 10601K - Air Reducer, 6" Whip-Hose



MODEL 10202



MODEL 10200



MODEL 10201

Combi Style Bead Breaker - For Single, Two, & Three Piece Tires/Rims

Model #10895



MODEL 10895

- ▶ Used on single, two, and three piece wheel truck tires and rims.
- ▶ Works on some of the newly styled wheels.
- ▶ Most popular tool for breaking beads on agricultural wheels.
- ▶ Tool hydraulically clamps on the wheel.
- ▶ 3.75" inch stroke | 95mm
- ▶ Used with 10,000 psi air hydraulic pumps.
- ▶ Weight: 35 lbs. | 16 kg

MODEL 10820

- 10895 - Combi Style Bead Breaker Tool
- 10875 - Pump, Air Hydraulic, 5 Quart
- 10604 - Hose Assembly with Hose Coupler, 8'
- 10601K - Air Reducer, 6" Whip-Hose

MODEL 10821

- 10895 - Combi Style Bead Breaker Tool
- 10877 - Metal Pump, Air Hydraulic, 5 Quart
- 10604 - Hose Assembly with Hose Coupler, 8'
- 10601K - Air Reducer, 6" Whip-Hose



MODEL 10820



MODEL 10821

Maxi Bead Breaker - For 3 Piece Wheels, with Extended Flange

Model #10102

OSHA



MODEL 10102

- 1 Extended Jaw for Deep Dished Style Wheels**
- 2 Replaceable teeth 1.25" longer than Standard #10101**
- 3 13.8 Tons of Bead Breaking Force**

- ▶ Works on ALL 3 piece wheels with extended flange that have replaced the older 5 piece wheels.
- ▶ Designed to work on front or back of the wheel with no attachments or accessories.
- ▶ Clamps easily to the wheel.
- ▶ Longer Feet and Claw than "Combi" Bead Breaker #10101
- ▶ No Set up Time.
- ▶ Weight: 38 lbs. | 17 kg

MODEL 10221

KITS:

- 10102- "Maxi" Bead Breaker Tool
- 10500 - Turbo II Pump, Air Hydraulic, 3 1/2 Quart
- 10604 - Hose Assembly with Hose Coupler 8'
- 10601K - Air Reducer, 6" Whip-Hose



MODEL 10221

Point.Scan.Explore.



Euro Style Bead Breaker - Lightweight Aluminum Bead Breaker

Model #10107

OSHA

ALUMINUM
HYDRAULIC BEAD BREAKERS *SERIES*



MODEL 10107

- 1 Hook clamp specifically designed for 3 piece wheels**
- 2 Specialty designed foot pushing against bead**
- 3 Lightweight Aluminum Construction**
- 4 T-Handle for Easy Use and Positioning**

- ▶ Lightweight Aluminum Bead Breaker - Reduces weight of the tool 20+%
- ▶ Works on all single piece, 2 piece & 3 piece tires & rims.
- ▶ 13.8 Tons of Bead Breaking Force
- ▶ 4.25" Stroke | 108mm
- ▶ Weight: 32 lbs. | 15 kg

MODEL 10220

KITS:

- 10107 - Bead Breaker
- 10592 - Pump, Air Hydraulic 5 Quart
- 10604 - Hose Assembly with Hose Coupler, 8'
- 10601K - Air Reducer, 6" Whip-Hose



Point.Scan.Explore.



MODEL 10220

Talon Bead Breaker - Use on HD 3-Piece Rims w/ Extended Flange

Model #10109

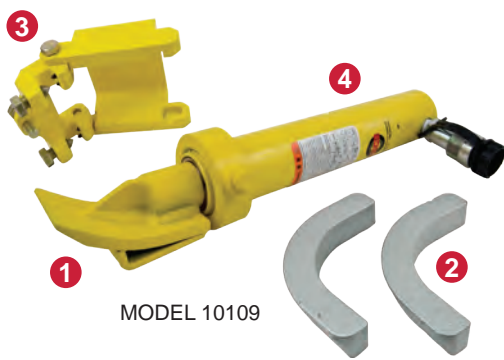

MODEL 10109

Point.Scan.Explore.



- 1 Foot/Spade
- 2 Wedges
- 3 Clamp Assembly
- 4 10 Tons of Bead Breaking Force, 8.25" Stroke | 210mm

- ▶ OTR Bead Breaker for heavy duty 3 piece rims with extended flange that have replaced standard 5 piece rims.
- ▶ Works on both front and back of wheel without dismounting wheel from the vehicle.
- ▶ Works on all new 3 piece 25" wheels or larger.
- ▶ **A MUST Have for all tire trucks.**
- ▶ Weight: 30 lbs. | 13 kg



MODEL 10223

- KITS:**
- 10109 - Bead Breaker
 - 10592 - Pump, Air Hydraulic 5 Quart
 - 10604 - Hose Assembly with Hose Coupler, 8'
 - 10601K - Air Reducer, 6" Whip-Hose



MODEL 10223

Giant Tire Bead Breaker - Earthmover Tire/Wheels

Model #10105

OSHA

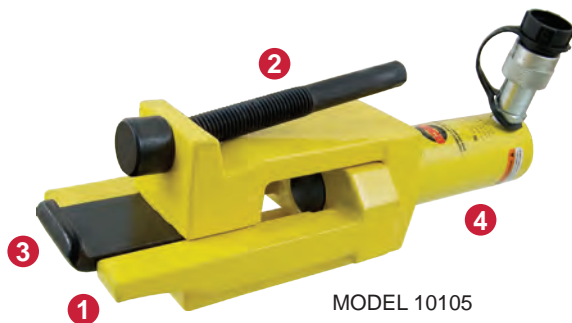

MODEL 10105

Point.Scan.Explore.



- 1 Clevis Support
- 2 Alignment Screw
- 3 Jaw/Hook
- 4 10 Tons of Bead Breaking Force, 2" Stroke. | 51mm

- ▶ Smaller more compact design.
- ▶ Use only on 5 piece rims 25" and 29" earthmover tire/wheel with pry bar/bead loosening pocket.
- ▶ 2" Stroke.
- ▶ 10 Ton hydraulic ram easily breaks most beads.
- ▶ Used with 10,000 psi air/hydraulic pump.
- ▶ Compact design fits on the backside of most wheels.
- ▶ Weight: 24 lbs. | 11 kg

MODEL 10222

- KITS:**
- 10105 - 10105 Bead Breaker
 - 10592 - Pump, Air Hydraulic, 5 quart
 - 10604 - Hose Assembly with Hose Coupler, 8'
 - 10601K - Air Reducer, 6" Whip-Hose



MODEL 10222



Combi Style Aluminum Bead Breaker - 10 Tons of Force, 2.75" Stroke

Model #40801



MODEL 40801

ALUMINUM
HYDRAULIC BEAD BREAKERS
SERIES

- ▶ **Aluminum Construction - Lightweight**
- ▶ 10 Tons of Bead Breaking Force
- ▶ Comparable to the #10101, Combi Bead Breaker
- ▶ To be used on 3-Piece Wheel Assemblies.
- ▶ Extended Jaw for Deep Dish Style Wheels (Extended Flange)
- ▶ Stroke: 2.75" | 70mm
- ▶ Weight: 19 lbs. | 8.5 kg

SPECIFICATIONS

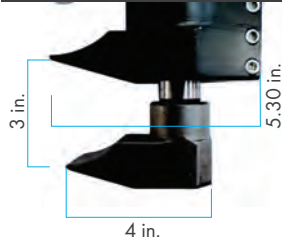

MODEL 10247

- 40801 - "Combi" Bead Breaker Tool**
10592 - Pump, Air Hydraulic, 5 Quart
10604 - Hose assembly with Hose Coupler, 8'
10601K - Air Reducer, 6" Whip-Hose

MODEL 10246

- 40801 - "Combi" Bead Breaker Tool**
10590 - Pump, Air Hydraulic, 2 1/2 Quart
10604 - Hose Assembly with Hose Coupler, 8'
10601K - Air Reducer, 6" Whip-Hose

MODEL 10245

- 40801 - "Combi" Bead Breaker Tool**
10500 - Turbo II Pump, Air Hydraulic, 3 1/2 Quart +
10604 - Hose Assembly with Hose Coupler, 8'
10601K - Air Reducer, 6" Whip-Hose



MODEL 10247



MODEL 10246



MODEL 10245

Aluminum Bead Breaker - 20 Tons of Force, For 5 Piece Wheels

Model #40802



MODEL 40802

ALUMINUM
HYDRAULIC BEAD BREAKERS
SERIES

- ▶ **Aluminum Construction - Lightweight**
- ▶ **Specialty Designed Claws** - Able to be used on Wheels with Smaller Bead Pockets. (see chart below)
- ▶ **Includes:** (2) Aluminum Style Wedges **40208-20** to increase usage on wider range of wheel assemblies & **40802-6A** Claw to be used on 5 Piece Wheel Assemblies 25" - 51"
- ▶ Bead Breaker with Swivel Style Coupler Available: Model #40802S
- ▶ Stroke: 2.75" | 70mm
- ▶ 20 Tons of Bead Breaking Force
- ▶ Weight: 17.6 lbs. | 8 kg

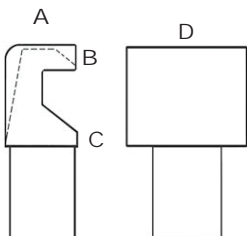

Part #	A	B	C	D
40802-6A	1.18" 30mm	0.31" 8mm	3" 78mm	1.7" 43mm
40802-6B	1.14" 29mm	0.4" 10mm	3" 78mm	1.7" 43mm
40802-6C	1.42" 36mm	0.4" 10mm	4" 100mm	2" 50mm
40802-6D	1.18" 30mm	0.35" 9mm	3.35" 85mm	1.5" 37mm



Giant Tire/Earthmover Bead Breaker

Model #10100

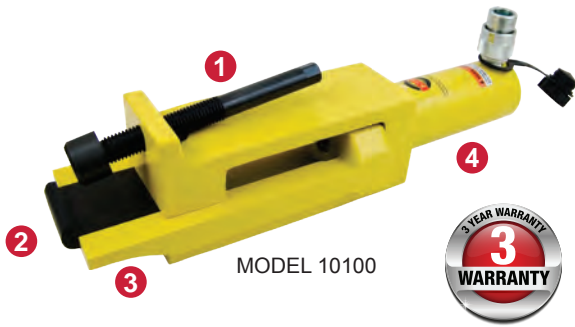

- 1** Alignment Screw
- 2** Jaw/Hook
- 3** Clevis Support
- 4** 13.8 Tons of Bead Breaking Force, 4" Stroke. | 102mm

OSHA

Use on 5-piece rims 25" to 51" with pry bar/bead loosening pockets. Ram will break the toughest of beads. Use with 10,000 PSI Hydraulic Pump. Weight 31 lbs. | 14 kg

MODEL 10209

- KITS:**
- 10100 - Giant Tire Bead Breaker Tool
 - 10592 - Pump, Air Hydraulic, 5 quart
 - 10604 - Hose Assembly with Hose Coupler, 8'
 - 10601K - Air Reducer, 6" Whip-Hose

MODEL 10207

- 10100 - Giant Tire Bead Breaker Tool
- 10500 - Turbo II pump, Air Hydraulic, 3 1/2 Quart
- 10604 - Hose Assembly with Hose Coupler, 8'
- 10601K - Air Reducer, 6" Whip-Hose



MODEL 10209

MODEL 10207

10607 Caterpillar Shur-Lok Kit

- Model 10607 is for use on Caterpillar vehicles with modified Shur-Lok rims
- Allows bead breaker to be tightened against a flat surface
- Fits all style earth mover bead breakers, except:
 - #10104 (Goodyear TO-100)
 - #10103 (Goodyear TO-2000)



MODEL 10607

Point.Scan.Explore.



Giant Tire/Earthmover Bead Breaker

Model #10896

OSHA



MODEL 10896

Point.Scan.Explore.



- ▶ Use on 5 piece 25" to 51" with pry bar/bead loosening pockets
- ▶ 4.25" Stroke | 108mm
- ▶ 13.8 Ton Ram will break the toughest beads
- ▶ Used with 10,000 psi air hydraulic pumps
- ▶ Weight: 29 lbs. | 13 kg

MODEL 10822

- KITS:**
- 10896 - Giant Tire Bead Breaker Tool
 - 10875 - Pump, Air Hydraulic, 5 Quart
 - 10604 - Hose Assembly with Hose Coupler, 8'
 - 10601K - Air Reducer, 6" Whip-Hose

MODEL 10823

- 10896 - Giant Tire Bead Breaker Tool
- 10877 - Metal Pump, Air Hydraulic, 5 Quart
- 10604 - Hose Assembly with Hose Coupler, 8'
- 10601K - Air Reducer, 6" Whip-Hose



MODEL 10822



MODEL 10823

Giant Tire Bead Breaker Head - Use on 5-Piece Rims 25" - 51"

Model #10104

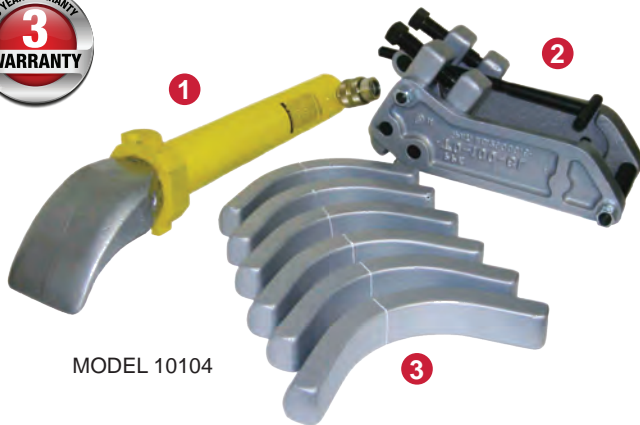

MODEL 10104

- 1 Ram Assembly - Part #10216 - 10" Stroke
- 2 Frame Assembly
- 3 Wedges

- ▶ Use on 5-piece rims 25" to 51" **without pry bar/ bead loosening pockets.**
- ▶ Replaces Goodyear TO-100-HA.
- ▶ Stroke: 10" | 254mm
- ▶ Includes #10216 Ram Assembly, #10215 Frame Assembly, and Wedges.
- ▶ Weight: 68 lbs. | 31 kg



Point.Scan.Explore.



MODEL 10212

KITS:

- 10104 - Bead Breaker
- 10500 - Turbo II Pump, Air Hydraulic, 3 1/2 Quart
- 10604 - Hose Assembly with Hose Coupler, 8'
- 10601K - Air Reducer, 6" Whip-Hose



MODEL 10212

Giant Tire Bead Breaker - For 39" Rims & Larger

Model #10103



MODEL 10103

- 1 Plunger
- 2 Frame
- 3 Hook
- 4 **25 Tons of Bead Breaking Force, 6" Stroke. | 152mm**

OSHA

- ▶ Use on 5 piece rims 39", 45", 51", 57", and 63" wheel sizes.
- ▶ In some cases you must first use #10105 or the #10100 bead breaker to start the movement of the rim flange; the #10103 can then be used.
- ▶ #10594, air/hydraulic pump is recommended for operation.
- ▶ The #10627 Kit converts the #10103 into a 10103L, which is capable of Working on 63" Rims.
- ▶ Weight: 54 lbs. | 25 kg



MODEL 10627 Kit on 10103

Point.Scan.Explore.



MODEL 10211

KITS:

MODEL 10211

- 10103 - Giant Tire Bead Breaker Tool
- 10594 - Turbo Pump II, Air Hydraulic, 2 Gallon
- 10611 - 18' Hydraulic Hose
- 10605 - Male Coupler with female threads
- 10601K - Air Reducer, 6" Whip-Hose



Euro Style Aluminum Bead Breaker - Standard Hook

Model #40804

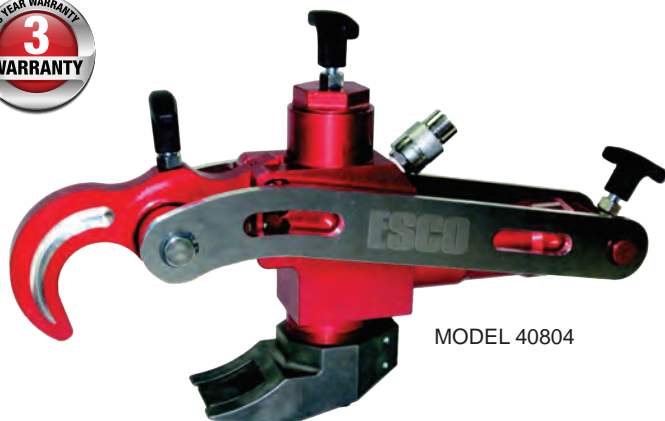

MODEL 40804

ALUMINUM
HYDRAULIC BEAD BREAKERS *SERIES*

- ▶ **Aluminum Construction - Lightweight**
- ▶ Detaches inside and outside truck and tractor tire bead breakers from rims.
- ▶ For 3-Piece Wheel Assembly
- ▶ Works on Caterpillar Rims from 25" to 57"
- ▶ 5 Tons of Bead Breaking Force
- ▶ Stroke: 3" | 75mm
- ▶ Weight: 38 lbs. | 17 kg

Specialty Claw Adaptor - For Volvo Style Wheels Model #40804-VA



▶ "VOLVO" Adaptor Claw For Inside Rim Bead Breaking Application.

SPECIFICATIONS

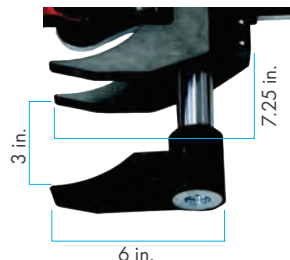

KITS:

MODEL 10240

- 40804 - Bead Breaker
- 10592 - Pump, Air Hydraulic 5 Quart
- 10604 - Hose Assembly with Hose Coupler, 8'
- 10601K - Air Reducer, 6" Whip-Hose

MODEL 10241

- 40804 - Bead Breaker
- 10500 - Turbo II Pump, Air Hydraulic, 3 1/2 Quart
- 10604 - Hose Assembly with Hose Coupler, 8'
- 10601K - Air Reducer, 6" Whip-Hose



MODEL 10240



MODEL 10241

Euro Style Aluminum Bead Breaker - Long Hook

Model #40805



MODEL 40805

ALUMINUM
HYDRAULIC BEAD BREAKERS *SERIES*

- ▶ **Aluminum Construction - Lightweight**
- ▶ Earthmover Style Bead Breker for EM Tires 25" to 57"
- ▶ For 3-Piece Wheel Assembly
- ▶ Great for use on Caterpillar 952G, 924G, Volvo L120 Rim Configurations.
- ▶ 5 Tons of Bead Breaking Force
- ▶ Stroke: 4.75" | 120mm
- ▶ Weight: 39 lbs. | 17.4 kg

SPECIFICATIONS

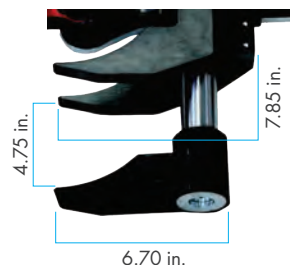

KITS:

MODEL 10242

- 40805 - Bead Breaker
- 10592 - Pump, Air Hydraulic 5 Quart
- 10604 - Hose Assembly with Hose Coupler, 8'
- 10601K - Air Reducer, 6" Whip-Hose

MODEL 10243

- 40805 - Bead Breaker
- 10500 - Turbo II Pump, Air Hydraulic, 3 1/2 Quart
- 10604 - Hose Assembly with Hose Coupler, 8'
- 10601K - Air Reducer, 6" Whip-Hose



MODEL 10242



MODEL 10243

Dual Agricultural Bead Breaker - For Inner Bead on Duals

Model #10106



MODEL 10106

- ▶ Heavy Duty; uses 10 Tons of Bead Breaking Force
- ▶ Breaks the inner bead on dual farm tractor tires.
- ▶ Requires just 3" of operating space between the dual tractor tires.
- ▶ No need to remove the outside wheel to change the tire on the outside dual.
- ▶ Use with a 10,000 psi air/hydraulic pump.
- ▶ Weight: 54 lbs. | 25 kg



KITS:

MODEL 10203

- 10106 - Bead Breaker
- 10500 - Pump, Hydraulic 3.5 Quart
- 10604 - Hose Assembly with Hose Coupler, 8'
- 10601K - Air Reducer, 6" Whip-Hose



MODEL 10203



Slide Hammer Bead Breaker- Manual Style Bead Breaker

Model #70150

OSHA



MODEL 70150



- ▶ Breaks the most stubborn beads with ease.
- ▶ Reduces user fatigue with its spring action design.
- ▶ This design prevents slide hammer kick back.
- ▶ The wedge foot is forced between the bead and rim flange, delivering blow directly to the tip.
- ▶ Heavy duty tool, will not break.
- ▶ Comparable to the Ken Tool T26B.
- ▶ Weight: 24 lbs. | 11 kg

Manual Bead Breaker - For Small ATV Tires and Up

Model #70160



MODEL 70160

- ▶ Loosens tire bead from the rim with leverage.
- ▶ Excellent for working on the tire without removing the wheel.
- ▶ Will handle 38" and 42" 14-ply farm tractor and backhoe tires with drop center rims to small ATV and lawn mower tires.
- ▶ Operates with air ratchet wrench or ratchet & socket.
- ▶ Reinforced Bead Hook with Steel Brackets to Create better leverage on rim & add dexterity.
- ▶ **DO NOT USE AIR IMPACT TOOL**
- ▶ Weight: 12 lbs. | 5 kg



Pneumatic Bead Breaker - Impact/Air Wrench Operated

Model #20429



MODEL 20429

- 1 Clamping Jaw
- 2 Clamp Tightening Screw
- 3 Foot Screw

- ▶ Loosens tire bead from the rim with leverage.
- ▶ Excellent for working on the tire without removing the wheel.
- ▶ Will handle much wider range of tires from ATV, mower, automotive tires and up.
- ▶ Operates with impact wrench and or air ratchet wrench.
- ▶ 5" Stroke | 127mm
- ▶ Weight: 13 lbs. | 6 kg

Point.Scan.Explore.



Bead Push-Off Tool - Acts Like a Third Arm

Model #10108



MODEL 10108



- ▶ Lightweight tool for removing combine, forestry, and tractor tires after breaking the bead
- ▶ Acts as a "Third Hand"
- ▶ Has a pushing force of 8,000 lbs. and a 5.5" stroke
- ▶ A removable handle for compact storage and uses hydraulic pressure to force the tire off the rim
- ▶ The push off tool hooks between the rim and the tire bead
- ▶ Weight: 9 lbs. | 4 kg

Truck Tire Double Bead Breaker

Model #20425



MODEL 20425

Point.Scan.Explore.



- ▶ Break Both Tire Beads at the Same Time.
- ▶ Works on most Truck Tire Sizes - 19.5-24.5 + Super Singles & X-One Wide Base Types.
- ▶ No More Back Injuries from Lifting 300 + lbs. Tires.
- ▶ Simple Operation
- ▶ Compact Storage
- ▶ Breaks the Bead with 5,000 lbs. of Force.
- ▶ Limits Workman's Compensation Claims.
- ▶ Weight: 115 lbs. | 52 kg



Air Reducer for Air/Hydraulic Equipment

Model #10601

INCREASES
the Longevity
of Hydraulic
Equipment!



MODEL 10601

- ▶ Maintain recommended working Air Pressure.
- ▶ Easy Installation & Usage
- ▶ 10601K Comes with Air Reducer & Whip-Hose (ESCO Model #10601H)
- ▶ Can be used in conjunction with multiple ESCO Products.
- ▶ Diameter: 15/16" | 24mm
- ▶ Working Air Pressure: 110 PSI
- ▶ Air Inlet Size: 1/4" NPT
- ▶ Shipping Weight: 1 lbs. | 0.5 kg

KIT OFFERING

10601K Air Reducer will be included with ALL Hydraulic Pump & Bead Breaker Kits!

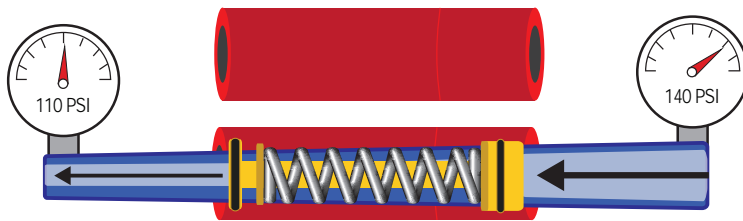

MODEL 10601K being used on ESCO 10500 Hydraulic Pump to regulate air pressure down to the manufacturer suggested 110 psi.

3.5 Quart Turbo II Air Hydraulic Pump

Model #10500



MODEL 10500

- ▶ 3.5 quart oil capacity.
- ▶ Rugged, Lightweight Plastic Reservoir with polyglass sight gauge.
- ▶ 10,000 psi hydraulic pressure.
- ▶ Easily works on rams and bead breakers with oil to spare.
- ▶ Compact design easily fits storage bins.
- ▶ **FASTEST PUMP AVAILABLE.**
- ▶ Shipped with premium hydraulic oil.
- ▶ Weight: 18lbs. | 8 kg

KITS:

MODEL 10501

- 10500 - Turbo II Air Hydraulic Pump 3 1/2 Quart
- 10610 - Hose Assembly, 8'
- 10601K - Air Reducer, 6" Whip-Hose

MODEL 10501C

- 10500 - Turbo II Air Hydraulic Pump 3 1/2 Quart
- 10604 - Hose Assembly with Hose Coupler, 8'
- 10601K - Air Reducer, 6" Whip-Hose



5 Quart Metal Reservoir Air Hydraulic Pump

Model #10592



MODEL 10592

- ▶ Enough oil capacity to operate lifting jacks, cylinders, and then switch to bead breaking tools.
- ▶ Rugged 5 quart metal reservoir.
- ▶ 10,000 psi hydraulic pressure
- ▶ Specifically designed for tire service trucks.
- ▶ Air inlet filter keeps air clean.
- ▶ All metal air motor.
- ▶ Weight 27lbs. | 12 kg



KITS: MODEL 10593

- 10592 - Air Hydraulic Pump 5 Quart
- 10610 - Hose Assembly, 8'
- 10601K - Air Reducer, 6" Whip-Hose

MODEL 10593C

- 10592 - Air Hydraulic Pump 5 Quart
- 10604 - Hose Assembly with Hose Coupler, 8'
- 10601K - Air Reducer, 6" Whip-Hose

5 Quart Metal Reservoir Air Hydraulic Pump

Model #10877



MODEL 10877

- ▶ For use with a variety of rams, presses, and hydraulic tools operating up to 10,000 psi
- ▶ Has an internal load limiting device
- ▶ Air exhaust muffler for quiet pumping of air motor
- ▶ Equipped with air and oil inlet filters to reduce the risk of contamination
- ▶ Weight 30 lbs. | 14 kg



KITS: MODEL 10877C

- 10877 - Air Hydraulic Pump 5 Quart
- 10604 - Hose Assembly with Hose Coupler, 8'
- 10601K - Air Reducer, 6" Whip-Hose

5 Quart Plastic Reservoir Air Hydraulic Pump

Model #10875



MODEL 10875

- ▶ For use with a variety of rams, presses, and hydraulic tools operating up to 10,000 psi
- ▶ With internal load limiting device
- ▶ Air exhaust muffler for quiet pumping of air motor
- ▶ Equipped with Air and oil inlet filters to reduce the risk of contamination
- ▶ Weight 22 lbs. | 10 kg



KITS: MODEL 10875C

- 10875 - Air Hydraulic Pump 5 Quart
- 10604 - Hose Assembly with Hose Coupler, 8'
- 10601K - Air Reducer, 6" Whip-Hose

1/2 Gallon Air Hydraulic Pump

Model #10876



MODEL 10876

- ▶ For use with a variety of rams, presses and hydraulic tools operating up to 10,000 psi
- ▶ Air exhaust muffler for quiet pumping of air motor
- ▶ Air and oil inlet filters for reducing risk of damage from contamination.
- ▶ 19 lbs. | 8.6kg



KITS: MODEL 10876C

- 10876 - Air Hydraulic Pump 1/2 Gallon
- 10604 - Hose Assembly with Hose Coupler, 8'
- 10601K - Air Reducer, 6" Whip-Hose

2 Gallon Metal Reservoir Air Hydraulic Pump

Model #10594



MODEL 10594

- ▶ MAXIMUM Oil Capacity - For Any Hydraulic Tool Application.
- ▶ Rugged 2 Gallon Metal Reservoir.
- ▶ 10,000 psi hydraulic pressure
- ▶ Designed for use in the field, service truck or service center with multiple hydraulic tools.
- ▶ Air inlet filter keeps air clean.
- ▶ All metal air motor.
- ▶ Weight 34 lbs. | 15 kg



KITS:

MODEL 10595

- 10594 - Air Hydraulic Pump 2 Gallon
- 10610 - Hose Assembly, 8'
- 10601K - Air Reducer, 6" Whip-Hose

MODEL 10595C

- 10594 - Air Hydraulic Pump 2 Gallon
- 10604 - Hose Assembly with Hose Coupler, 8'
- 10601K - Air Reducer, 6" Whip-Hose



2 1/2 Quart Air Hydraulic Pump

Model #10590



MODEL 10590



- ▶ High density 2 1/2 quart polyethylene reservoir. Same as OTC 4020.
- ▶ Lightweight.
- ▶ Air inlet filter keeps air clean.

- ▶ All metal air motor.
- ▶ 10,000 psi hydraulic pressure.
- ▶ Weight: 16 lbs. | 7 kg

MODEL 10591

- 10590 - 2 1/2 Quart Pump
- 10610 - Hose Assembly, 8'
- 10601K - Air Reducer, 6" Whip-Hose



MODEL 10591

Hand Operated 1 Quart Hydraulic Pump - Manual Pump

Model #10508



MODEL 10508

- ▶ Hand Operated Hydraulic Pump.
- ▶ 1 quart oil capacity .
- ▶ 10,000 psi hydraulic pressure.
- ▶ Shipped with premium hydraulic oil.
- ▶ Weight: 14 lbs. | 7 kg

Available in Other Oil Capacities and Speeds

MODEL 10508HC

- 10508 - Air Hydraulic Pump, 1 Quart
- 10604 - Hose Assembly with Hose Coupler, 8'



MODEL 10508HC

Hydraulic Rams - Break Beads on Backside of Tires



Hydraulic Rams are a staple for any Tire Dealer/Technician that service **Earthmover Tires**. They are used to break the beads on the backside of the tire. In this case, clearance may make it difficult to use a bead breaker due to a limitation of space behind the wheel.



Model #	Tonnage	Retracted Hgt.	Stroke	Weight
10301	10 Tons	4.75" 121mm	2.13" 54mm	6 lbs. 3 kg
10302	10 Tons	6.75" 172mm	4.13" 105mm	8 lbs. 4 kg
10303	10 Tons	9.75" 248mm	6.13" 156mm	11 lbs. 5 kg
10304	10 Tons	11.75" 299mm	8" 203mm	12 lbs. 5 kg
10305	10 Tons	13.75" 350mm	10.13" 257mm	14 lbs. 6 kg
10306	30 Tons	4.63" 118mm	2.44" 62mm	15 lbs. 7 kg

Hydraulic Ram Safety Stand - Compatible with most 10 Ton Rams

Model #10315

NEW!

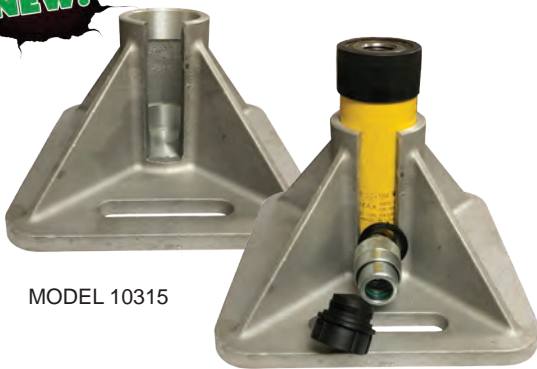

MODEL 10315

- ▶ Provides support and solid foundation when using hydraulic rams.
- ▶ Ram will not move or shift during lifting, saving from scarring or damaging cylinder.
- ▶ 9"x9" base footprint (greater service area for stablized lifting).
- ▶ LIGHTWEIGHT - Trasportable w/ carrying handle.
- ▶ Designed to fit most 10 Ton style rams in the market.
- ▶ Ram not included

Maximum Ram Tonnage	Max. Ram Diameter	Min. Ram Height	Max. Ram Height	Weight
10 Ton	2.5" 63.5mm	4.75" 120mm	13.75" 349mm	10 lbs. 4.5 kg

Hydraulic STAK-ABLE Ram - 10 Ton Ram with Extensions

Model #10807C



STACKABLE EXTENSIONS

MODEL 10807C

- ▶ High Quality expandable ram for a wide range of applications.
- ▶ Eliminates one of the industry's most dangerous jobs; Pushing rusted wheels off of hubs.
- ▶ Works Great on stubborn 22.5 and 24.5 wheels.
- ▶ Does the job where many other rams fall short or are too bulky to be usable in small spaces.
- ▶ Use on OTR and Commercial Truck Tires
- ▶ Extensions can be used individually or as a single long extension.

	Force	Stroke	Min. Height	Max. Height	Weight
	10 Ton	1" 25.4mm	3.5" 90mm	12" 305mm	12 lbs. 5.4 kg

A	B	C	D
0.4" 10mm	1" 25mm	2" 50mm	3.4-4.9" 87-125mm

100 Ton HD Jack - Heavy Duty Lightweight Hydraulic Cylinder

Model #10300



MODEL 10300

- ▶ Lightweight yet durable.
- ▶ For use with 10,000 psi pumps.
- ▶ Ships completely assembled with valve, coupler.
- ▶ Perfect for off highway tire work.
- ▶ The preferred jack for road service.

Tonnage	Stroke	Min. Height	Max. Height	Weight
100 Ton	6" 152mm	11.75" 299mm	17.75" 451mm	55 lbs. 25 kg

55 Ton HD Jack - Heavy Duty Lightweight Hydraulic Cylinder

Model #10308



MODEL 10308

- ▶ Lightweight yet durable.
- ▶ For use with 10,000 psi pumps.
- ▶ Ships completely assembled with valve, coupler, and 7" x 7" Base | 178mm x 178mm
- ▶ Perfect for off highway tire work.
- ▶ **HEAVY DUTY** Cylinder Wall 1/2" Thick | 13mm
- ▶ The preferred jack for road service.

Tonnage	Stroke	Min. Height	Max. Height	Weight
55 Ton	6" 152mm	11" 279mm	17" 432mm	39 lbs. 18 kg

55 Ton Tall Jack - Heavy Duty Lightweight Hydraulic Cylinder

Model #10312



MODEL 10312

- ▶ Lightweight yet durable.
- ▶ For use with 10,000 psi pumps.
- ▶ Ships completely assembled with valve, coupler, and 7" x 7" base | 178mm x 178mm
- ▶ Perfect for off highway tire work.
- ▶ **HEAVY DUTY** Cylinder Wall 11/16" Thick | 17.5mm

Tonnage	Stroke	Min. Height	Max. Height	Weight
55 Ton	6" 152mm	10.5" 267mm	16.5" 419mm	33 lbs. 15 kg

55 Ton High Lift Jack - Heavy Duty Lightweight Hydraulic Cylinder

Model #10314



MODEL 10314

- ▶ Lightweight yet durable.
- ▶ Ships completely assembled with valve, coupler, and 7" x 7" base | 178mm x 178mm
- ▶ The preferred jack for Mining.
- ▶ Portable jack delivers 55 tons of lifting from any 10,000 psi hydraulic pump.

Tonnage	Stroke	Min. Height	Max. Height	Weight
55 Ton	10" 254mm	14.375" 365mm	24.375" 619mm	41 lbs. 19 kg

Safety Locking Collar Jack - 50 & 100 Ton Capacity

OSHA
MSHA



- 1 Locking Collar Feature Permits No Hydraulic Support of Load.
 - 2 Turns Cylinder Into A Support Stand
 - 3 Locking Collar Features Insert Holes for Assisted Turning of Collar Under Load
- ▶ Safety Lock Nut For Mechanical Load Holding.
 - ▶ Designed for Use in Multiple Heavy Lifting Applications including OTR/Mining Vehicle Lifting.
 - ▶ High Tonnage: 50 Ton and 100 Ton Lifting Capacity.
 - ▶ Heavy Duty Aluminum Design at a Fraction of the Weight.
 - ▶ Lightweight and Compact Design makes Unit(s) Highly Portable.
 - ▶ High Flow Quick Connect Coupler for Easy Connection.
 - ▶ Overflow Port Functions as a Stroke Limiter.
 - ▶ Spring Return.
 - ▶ Features Carrying Handle for Easy Positioning of Cylinder.

The most important part of lifting a heavy load is the ability to sustain the load. While most instances support jack stands are used; the Locking Collar Cylinder acts as it's own self contained support stand.

According to OSHA/MSHA regulation 1926.305, "After the Load has been Raised, It Shall be Cribbed, Blocked, or Otherwise Secured at Once". Saving on Multiple Pieces of Equipment, the Locking Collar Cylinder allows for Easy Lock and Support for lifting any heavy load.

SPECIFICATIONS:

50 TON LIFTING CAPACITY



MODEL #10808

100 TON LIFTING CAPACITY



MODEL #10809

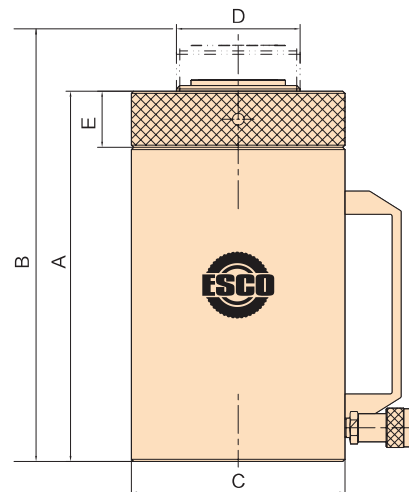

Cylinder Capacity 10,000 PSI 700 BAR	Stroke	Cylinder Ef- fective Area	Oil Capacity	Collapsed Height A	Extended Height B	Outside Diameter C	Piston Rod Diam. D	Nut Thickness E	Weight
Metric Ton	in	in ²	in ³	in	in	in	mm	in	lbs. kg
50	6.00	10.99	67.07	12.50	18.60	5.27	Tr80x4	1.57	26.4 12 kg
100	6.00	20.58	128.39	13.37	19.60	7.44	Tr110x6	1.97	66 30 kg

Premium Hydraulic Oil - Recommended Replacement Oil For ESCO Products



Recommended replacement Oil for ALL Hydraulic tools.
Best for use on Hydraulic Pumps, Hydraulic Jacks, Hydraulic Service Jacks and more.

#10901: 1 Gallon of Premium Hydraulic Oil

**#10902: 4 Gallons of Premium Hydraulic Oil
 1 Case (4 Gallons)**

Hydraulic Couplers

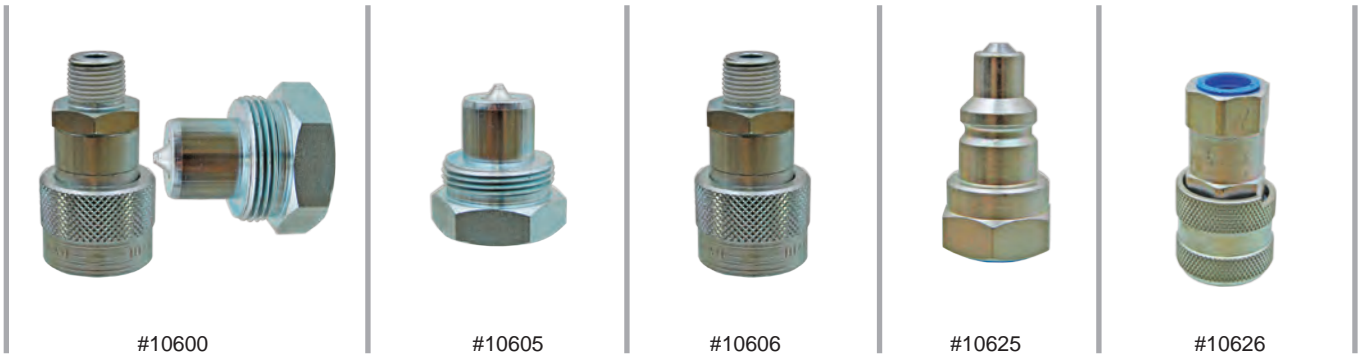

Model #	Description	PSI Rating
10600 Coupler Kit (High Flow)	Ram (female) Half #10606, Hose (male) Half #10605 (Interchangeable with OTC, Power Team, Enerpac, and All ESCO Hydraulic Products. 3/8"	10,000 PSI
10605	Male Coupler, Female Threads, 3/8"	10,000 PSI
10606	Female Coupler, Male Threads, 3/8"	10,000 PSI
10625 Quick Connect	Male Coupler, Female Threads (Parker Style Coupler interchangeable with IMT Tools), 3/8"	10,000 PSI
10626 Quick Connect	Female Coupler, Female Threads (Parker Style Coupler interchangeable with IMT Tools), 3/8"	10,000 PSI

Hydraulic Hoses



- ▶ Hydraulic hose with swivel fitting, hose won't kink.
- ▶ Reinforced with 2 layers of braided steel.
- ▶ Use with any 10,000 psi. pump, ram, or bead breaker.

Model #	Length	Attachments included:	Weight
10603	8 ft.*	#10600 Coupler	6 lbs. 3 kg
10604	8 ft.*	#10605 Half Coupler	5 lbs. 2.2 kg
10610	8 ft.*	Hose Only	4 lbs. 2 kg
10611	18 ft.*	Hose Only	9 lbs. 4 kg

* 8 Foot Hose with 3/8" 18 Male Ends

Jumbo Jacks - High Tonnage, High Lifting Field Jacks



Point.Scan.Explore.



- ▶ Ideal for: Giant Tire Changing, Mining, Railroads, Construction Rigging.
- ▶ Balanced for easy moving with Large pneumatic wheels.
- ▶ Only 23" wide, the jacks fit in tight spots
- ▶ 50" long, 8 position handle for easy tilt back and moving of the Jack.
- ▶ Welded fully enclosed heavy-duty steel frame with built in lifting holes.
- ▶ Rotary style air pump.
- ▶ Minimum 90 to 150 psi air supply needed to power hydraulic pump.
- ▶ Extension holders bolted to frame for easy storage.
- ▶ Easy to change air filter.
- ▶ All Jumbo Jacks come with 1" saddle, 5" & 9" Extensions. (Locking Rings Sold Separately)



Model #	Lifting Capability	Lowest Point	Stroke	Weight
10320	150 Tons	27" 686mm	14.4" 366mm	860lbs... 390 kg
10321	150 Tons	36" 914mm	22.4" 569mm	920 lbs. 417 kg
10322	100 Tons	27" 686mm	14.75" 375mm	860 lbs. 390 kg
10323	200 Tons	27" 686mm	14.5 368mm	1165 lbs. 528 kg
10324	250 Tons	27" 686mm	14" 356mm	1345 lbs. 610 kg

Jumbo Jack Accessories - Extension Saddles, Stacking Lock Rings, Saddles



Model #	Tonnage	Saddle	Weight.	Model #	Tonnage	Saddle	Weight.
10341	100 Tons	12" 305mm	71 lbs. 32 kg	10347	150 Tons	9" 229mm	66 lbs. 30 kg
10342	100 Tons	5" 127mm	39 lbs. 18 kg	10349	200 Tons	5" 127mm	55 lbs. 25 kg
10343	100 Tons	9" 229mm	66 lbs. 30 kg	10350	200 Tons	9" 229mm	91 lbs. 41 kg
10345	150 Tons	12" 305mm	71 lbs. 32 kg	10352	250 Tons	5" 127mm	63 lbs. 29 kg
10346	150 Tons	5" 127mm	39 lbs. 18 kg	10353	250 Tons	9" 229mm	107 lbs. 49 kg

Jumbo Jack Accessories - Stacking Lock Rings



Model #	Tonnage	Size	Weight
10354	150 Tons	1" 26mm	1.5 lbs. 0.7 kg
10355	150 Tons	10" 254mm	15 lbs. 0.7 kg
10356	150 Tons	3" 76mm	4.5 lbs. 2 kg
10357	150 Tons	6" 153mm	9 lbs. 4 kg

Jumbo Jack Accessories - Saddles



Model #	Tonnage	Saddle	Weight
10340	100 Tons	1" 26mm	12 lbs. 6 kg
10344	150 Tons	1" 26mm	12 lbs. 6 kg
10348	200 Tons	1" 26mm	16 lbs. 7 kg
10351	250 Tons	1" 26mm	18 lbs. 8 kg



The Mammut range of jacks offers service professionals a solution that is safe and easy to use, for all those operations to lift earthmoving, construction, quarry and mining machinery, where maintenance requires professional skills and expertise.

Available in various models depending on load capacity and use, each jack can be configured with a wide range of accessories to meet all demands: Load blocking system, Remote control for working safely, Various extensions to suit all operations.

All models are air/hydraulic operated and equipped with a dual descent valve for greater control when bearing weight and automatic piston return; they can also be fitted with a manual emergency pump (on request). For excellent handling during use and transport, every Mammut jack has: Folding handle, Wide pneumatic tires, Special hooks for transport.

30/60 Ton Jack

Model #91001



MODEL 91001

Working Air Pressure
145-175 PSI

Weight
208 lbs. | 94 kg

See Page 27 for
Mammut Jack
Accessories

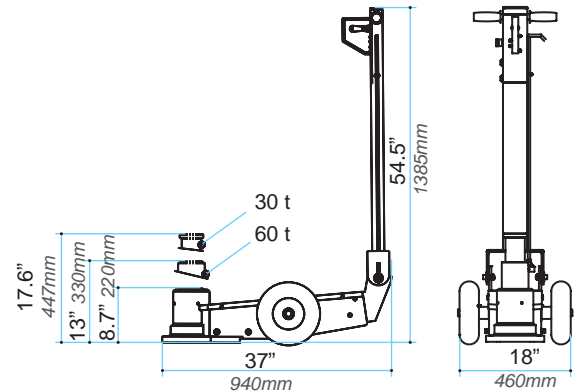

25/50/80 Ton Jack

Model #91000



MODEL 91000

Working Air Pressure
145-175 PSI

Weight
305 lbs. | 138 kg

See Page 27 for
Mammut Jack
Accessories

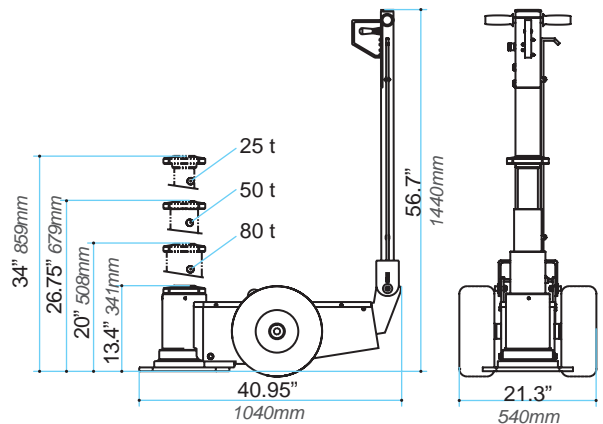

50/80 Ton Jack

Model #91003



MODEL 91003

Working Air Pressure
145-175 PSI

Weight
320 lbs. | 145 kg

See Page 27 for
Mammut Jack
Accessories

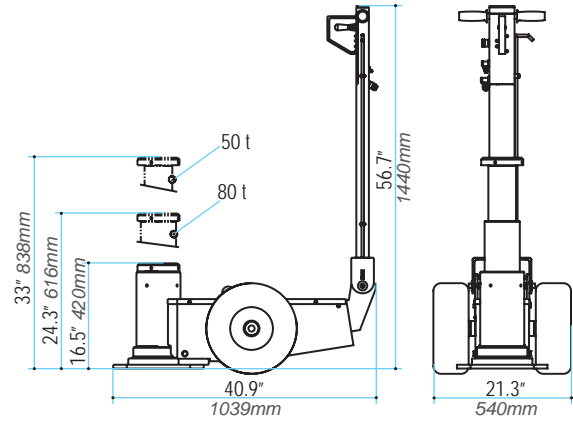

100 Ton Jack

Model #91004



MODEL 91004

Working Air Pressure
145-175 PSI

Weight
715 lbs. | 324 kg

See Page 27 for
Mammut Jack
Accessories

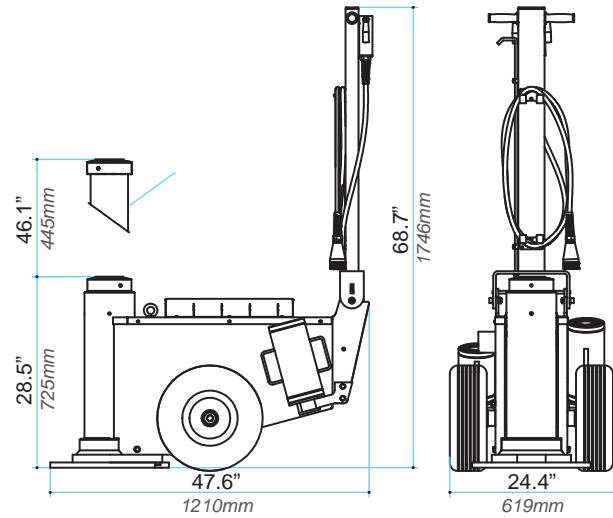

150 Ton Jack

Model #91005



MODEL 91005

Working Air Pressure
145-175 PSI

Weight
858 lbs. | 389 kg

See Page 27 for
Mammut Jack
Accessories

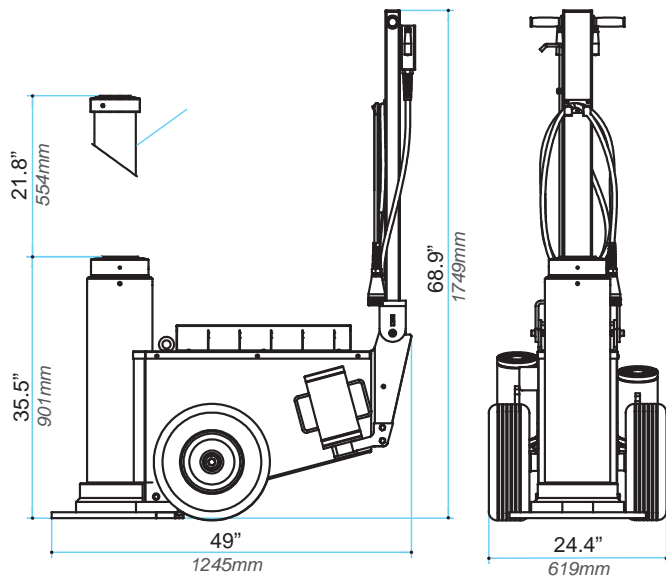

MAMMUT JACK ACCESSORIES

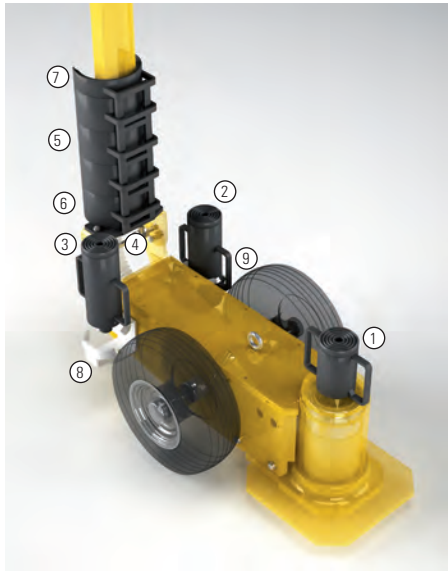

#91000

- ①- #91026 Extension 6" | 150mm
- ②- #91027 Extension 10" | 250mm
- ③- #91028 Extension 12" | 300mm
- ④- #91008 Safety Block Holder
- ⑤- #91015 Safety Blocks M/F, 7" | 177mm
- ⑥- #91016 Safety Blocks F/F, 7" | 177mm
- ⑦- #91017 Safety Blocks M/F, 7" | 177mm
- ⑧- #91033 Extension Holder R
- ⑨- #91032 Extension Holder L

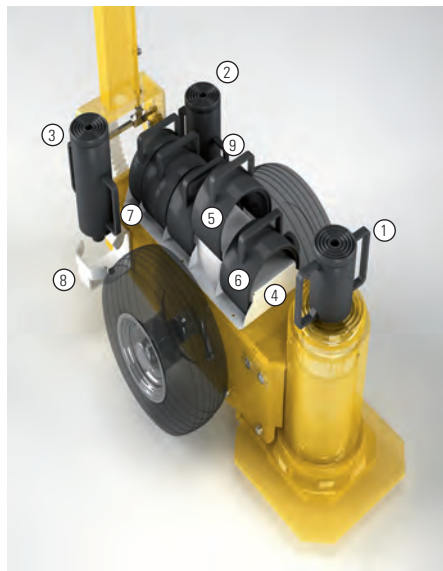

#91003

- ①- #91026 Extension 6" | 150mm
- ②- #91027 Extension 10" | 250mm
- ③- #91028 Extension 12" | 300mm
- ④- **KIT 91022** (1) Safety Block Holder
- ⑤- (3) Safety Blocks, M/F, 7" | 177mm
- ⑥- (1) Safety Blocks, F/F, 7" | 177mm
- ⑦- (1) Safety Blocks, M/F, 7" | 177mm
- ⑧- #91033 Extension Holder R
- ⑨- #91032 Extension Holder L



Handle Control For:
#91001 | #91000 | #91003
INCLUDED WITH JACK



INCLUDED WITH JACK
(16 ft. Hose)



Remote Control For:
#91004 | #91005



#91004

- ①- #91029 Extension 8" | 200mm
- ②- #91030 Extension 10" | 250mm
- ③- #91031 Extension 12" | 300mm
- ④- **KIT 91036** (1) Safety Block Holder
- ⑤- (3) Safety Blocks, M/F, 7" | 177mm
- ⑥- (1) Safety Blocks, F/F, 7" | 177mm
- ⑦- (1) Safety Blocks, M/F, 7" | 177mm
- ⑧- #91035 Extension Holder R
- ⑨- #91034 Extension Holder L



#91005

- ①- #91029 Extension 8" | 200mm
- ②- #91030 Extension 10" | 250mm
- ③- #91031 Extension 12" | 300mm
- ④- **KIT 91021** (1) Safety Block Holder
- ⑤- (3) Safety Blocks, M/F, 8.5" | 216mm
- ⑥- (1) Safety Blocks, F/F, 8.5" | 216mm
- ⑦- (1) Safety Blocks, M/F, 8.5" | 216mm
- ⑧- #91035 Extension Holder R
- ⑨- #91034 Extension Holder L

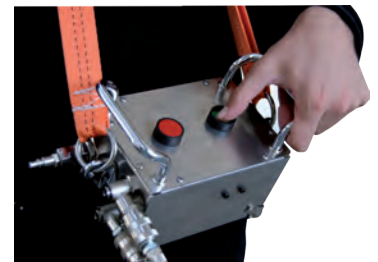

91006 Remote Control For:
#91001 | #91000 | #91003
Optional Remote Unit

Heavyweight Lifter Series Jacks



ESCO offers a wide and varied range of Heavyweight Lifter Series Jacks suitable for all heavy-duty vehicles from the shop to underground, mining, construction and railroad industries the Heavyweight Series continues to meet or exceed all the rugged demands of all heavy industrial applications. From 100 Ton through 350 ton.

Models Include:

Note: capacity requirements exceeding 350 tons can be manufactured on a "made to order" basis.



ESCO Part Number	Tonnage	Collapsed Cylinder in/cm	ESCO Part Number	Tonnage	Collapsed Cylinder in/cm
ESJ-100-27	100	27" 68.6cm	ESJ-250-27	250	27" 68.6cm
ESJ-100-38	100	38" 96.5cm	ESJ-250-38	250	38" 96.5cm
ESJ-150-27	150	27" 68.6cm	ESJ-300-27	300	27" 68.6cm
ESJ-150-38	150	38" 96.5cm	ESJ-300-33	300	33" 83.8cm
ESJ-200-27	200	27" 68.6cm	ESJ-350-27	350	27" 68.6cm
ESJ-200-38	200	38" 96.5cm	ESJ-350-33	350	33" 83.8cm

Heavyweight **CHAMP** Series Hydraulic Jacks

Fast, transportable, light, efficient and cost-effective. The CHAMP Series, High-Tonnage, Air-Hydraulic Jacks combine heavy-duty performance and reliability with ease of use, safety and mobility. Available in 100 Ton to 200 Ton capacities and starting lift points of 27" or 38" with extensions to take the starting lift point as high as 64".

CHAMP Series Options include:

- ▶ Safety LED Lighting (focused & surround)
- ▶ Safety Cribbing
- ▶ Foam - Filled Tires
- ▶ Remote Operation



ESCO Part Number	Tonnage	Cylinder Size in/cm
EJR-100-27	100	27" 68.6cm
EJR-100-38	100	38" 96.5cm
EJR-150-27	150	27" 68.6cm
EJR-150-38	150	38" 96.5cm
EJR-200-27	200	27" 68.6cm
EJR-200-38	200	38" 96.5cm

Heavyweight Lifter Series Jacks & Extensions Specifications

100, 125 & 150 TON UNITS ALL
HAVE THE SAME DIMENSIONS

	27" Cylinder		38" Cylinder	
	Imperial	Metric	Imperial	Metric
Minimum Height (A)	27"	69cm	38"	97cm
Maximum Height (B)	41.5"	107cm	65"	165cm
Cylinder Base (D)	18"	46cm	13"	33cm
Frame Length (E)	56.5"	144cm	96"	244cm
Handle Height (F)	40"	102cm	40"	102cm
Frame Width (G)	29"	74cm	29"	74cm
Unit Weight	990 lbs.	442.25 kg	1,545 lbs.	680.38 kg
A + Extension				
Min. Height with 6" Extension	33"	84cm	44"	112cm
Min. Height with 8" Extension	35"	89cm	46"	117cm
Min. Height with 10" Extension	37"	94cm	48"	122cm
Min. Height with 12" Extension	39"	99cm	50"	127cm
Min. Height with 14" Extension	41"	104cm	52"	132cm
Min. Height with 16" Extension	43"	109cm	54"	137cm
B + Extension = C				
Max. Height with 6" Extension	47.5"	120cm	71"	180cm
Max. Height with 8" Extension	50"	127cm	73"	185cm
Max. Height with 10" Extension	52"	132cm	75"	191cm
Max. Height with 12" Extension	54"	137cm	77"	196cm
Max. Height with 14" Extension	56"	142cm	79"	201cm
Max. Height with 16" Extension	58"	147cm	81"	206cm

* The jack shown includes the option Locking Collar (Cribbing) set as well as optional LED lighting

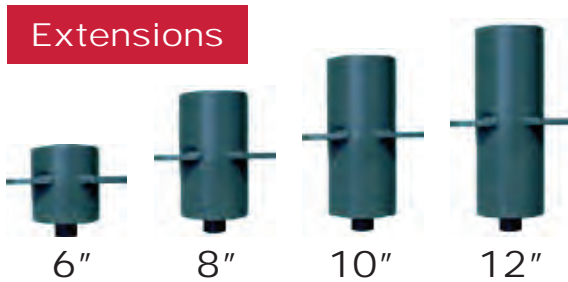
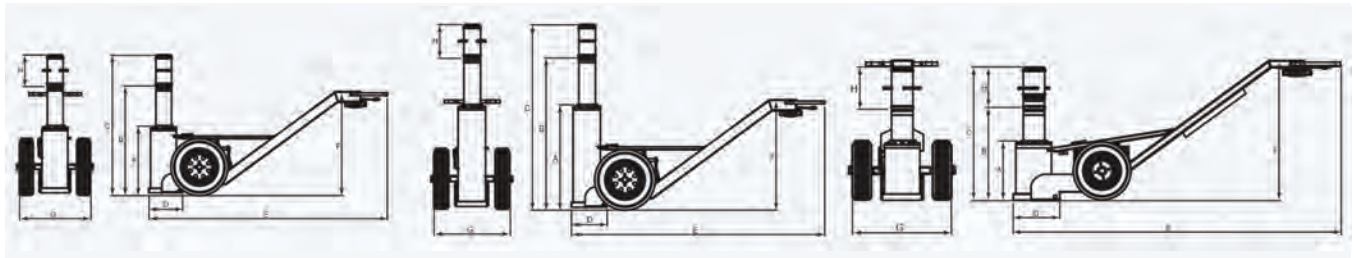

Min. Height w/ Ext. (Ext) (A+EXT)			Max. Height w/ Ext. (B + EXT = C)		
in	cm	in	in	cm	in
6"	15cm	33"	84"	47.5cm	120"
8"	20cm	35"	89"	50cm	127"
10"	25cm	37"	94"	52cm	132"
12"	30cm	39"	99"	54cm	137"

* Extensions can be custom manufactured to any height

Heavyweight Lifter Series Jack Stands

HEAVYWEIGHT JACKS STANDS



Because a load must always be supported by stands to protect employees working under the vehicle or equipment, ESCO produces an extensive range of Heavyweight support stands and extensions to meet the strictest International Safety Standards. Each ESCO support stand is constructed of high-density steel plate and high-strength tubing with durability and safety uppermost in design criteria. Even special paint is utilized to resist rough use in dirt and oil conditions. Our special stand/support systems for underground use have been also recently introduced.

Standard product features and benefits:

- ▶ Serial numbered and supplied with complete service and parts operation manuals
- ▶ Specially painted to resist corrosion from rough use in dirt and oil to improve durability
- ▶ Two extensions are supplied with each stand
- ▶ Custom extensions built to suit customer specs

ESCO Heavyweight Lifter Jack Stands are Custom Designed for specific application. They can be used in all supporting situations. For more information please contact an ESCO Representative.

Available in:

- ▶ 50 Tons
- ▶ 100 Tons
- ▶ 125 Tons
- ▶ 150 Tons
- ▶ 200 Tons
- ▶ 250 Tons
- ▶ 300 Tons



SECURING THE LOAD & CRIBBING

FEATURES OF ESCO CRIBBING

- ▶ 100% recycled plastic construction for added durability*
- ▶ Unmatched strength - stronger than oak
- ▶ Resistant to gas, oil, chemicals, and more
- ▶ 50 year warranty against splitting, rotting, absorption, termites and mold
- ▶ Lightweight and splinter free
- ▶ Available in black and HI-VIS yellow
- ▶ Repeatability

* Against splitting, rot, fluid absorption, termites or mold

Attribute	Plastic	Wood
Absorption	Almost Zero	Everything
Splitting	None	Yes
Knots	None	Yes
Stability	Very	No
Warranty	50 Years*	None
Lab Tested	Yes	No
Time	Very Fast	Slow
Environmentally Safe	Yes	Poor
P.S.I	700-1200	200-1000
Consistency	+/- 2%	0
Predictability	99%	0%

OSHA - Regulations

1926.305(d)(1)(i)

After the load has been raised, it shall be cribbed, blocked, or otherwise secured at once.

1926.305(c)

Blocking. When it is necessary to provide a firm foundation, the base of the jack shall be blocked or cribbed. Where there is a possibility of slippage of the metal cap of the jack, a wood block shall be placed between the cap and the load.

Information Provided by The OSHA Website at <http://www.osha.gov/>



(VARIES FROM 200 PSI TO 1000 PSI DEPENDING ON WOOD SPECIES
500 PSI IS USED HERE - EXAMPLE 500 x 3.5 x 3.5 x 4 = 24,000)

FOR 2 MEMBER x 2 MEMBER LAYOUT

4 x 4 CRIB CAPACITY = 24,000 LBS (12 TONS)
6 x 6 CRIB CAPACITY = 60,000 LBS (30 TONS)

FOR 3 MEMBER x 3 MEMBER CRIB, CAPACITY IS 9/4 AS MUCH
500 x 3.5" x 3.5" x 9 = 55,000, 500 x 5.5" x 5.5" x 9 = 136,000

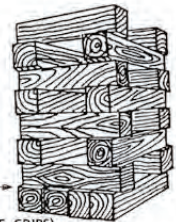

- BOTTOM LAYER SHOULD BE SOLID TO SPREAD THE LOAD ESPECIALLY ON SOIL OR ASPHALT PAVING
- LIMIT HEIGHT TO 3 TIMES WIDTH (SHORTEST WIDTH FOR NON-SQUARE CRIBS)
- OVERLAP CORNERS BY 4 INCHES TO ASSURE SLOW CRUSH TYPE FAILURE

Active -vs- Static Cribbing

Active cribbing is used when a person is working near the cribbing.

Static (or Passive) cribbing is used to keep material off the ground to allow a forklift to operate.

Design Strength

Cross grain bearing design strength for traditional wood cribbing varies by wood species from 200 PSI to 1000 PSI.

For example using:

500 PSI; Strength 500 x 3.5 x 3.5 x 4 = 24,000 lbs.

Plastic cribbing can sustain up to 700-1200 PSI. Creating a safer, longer lasting and more durable cribbing base.

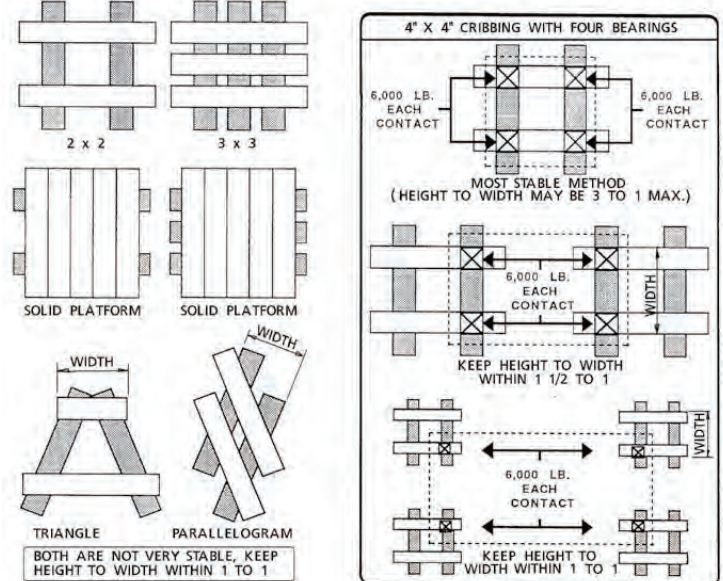

Steel Cribbing Stands - 3", 6", & 9" Stackers

OSHA



All pieces interlock and can be used individually or stacked together for various lift heights. They will not slide or shift during lifting.

MAXIMUM CAPACITY 55 TONS

Model #	Tonnage	Size	Wgt.
12500	55 50 Tonne	3"6"/9" 76mm/152mm/229mm	141 lbs. 64 kg
12501	55 50 Tonne	3" 76mm	38 lbs. 17 kg
12502	55 50 Tonne	6" 152mm	47 lbs. 21 kg
12503	55 50 Tonne	9" 229mm	56 lbs. 25 kg



Support Plates- For Use with Jacks to Create Stability

OSHA



MODEL 10751



MODEL 10753



MODEL 10754



MODEL 10752

- CORROSION PROOF
 - LIGHTWEIGHT
 - LIFETIME WARRANTY
- ▶ No more cracked, warped, bulky wooden blocks.
 - ▶ Lightweight, Corrosion & Rot-Proof
 - ▶ Will Not Absorb Moisture.
 - ▶ Up to 100 Ton weight capacity.
 - ▶ Will not break under load, mushroom, or warp.
 - ▶ Works with all types of jacks and doubles the surface area for the jack to sit on.
 - ▶ Great in soft earth or uneven ground.
 - ▶ Lifetime guarantee against breakage.
 - ▶ Allows Employer to comply with OSHA Regulation 29 CFR 1926.305 "Blocking for a Firm Foundation"



Jack Not Included

Model #	Tonnage	Size	Wgt.
10751	55 50 Tonne	12"x12"x1" 305x305x25mm	5 lbs. 2 kg
10752	25 22 Tonne	18"x18"x1" 457x457x25mm	11 lbs. 5 kg
10753	20 18 Tonne	12"x12"x1" 305x305x25mm	5 lbs. 2 kg
10754	100 90 Tonne	12"x12"x1" 305x305x25mm	6 lbs. 2 kg
10755	20/55/100 18/50/90 Tonne	12"x12"x1" 305x305x25mm	16 lbs. 7 kg

1926.305(d)(1)(i)

After the load has been raised, it shall be cribbed, blocked, or otherwise secured at once.

1926.305(c)

Blocking. When it is necessary to provide a firm foundation, the base of the jack shall be blocked or cribbed. Where there is a possibility of slippage of the metal cap of the jack, a wood block shall be placed between the cap and the load.

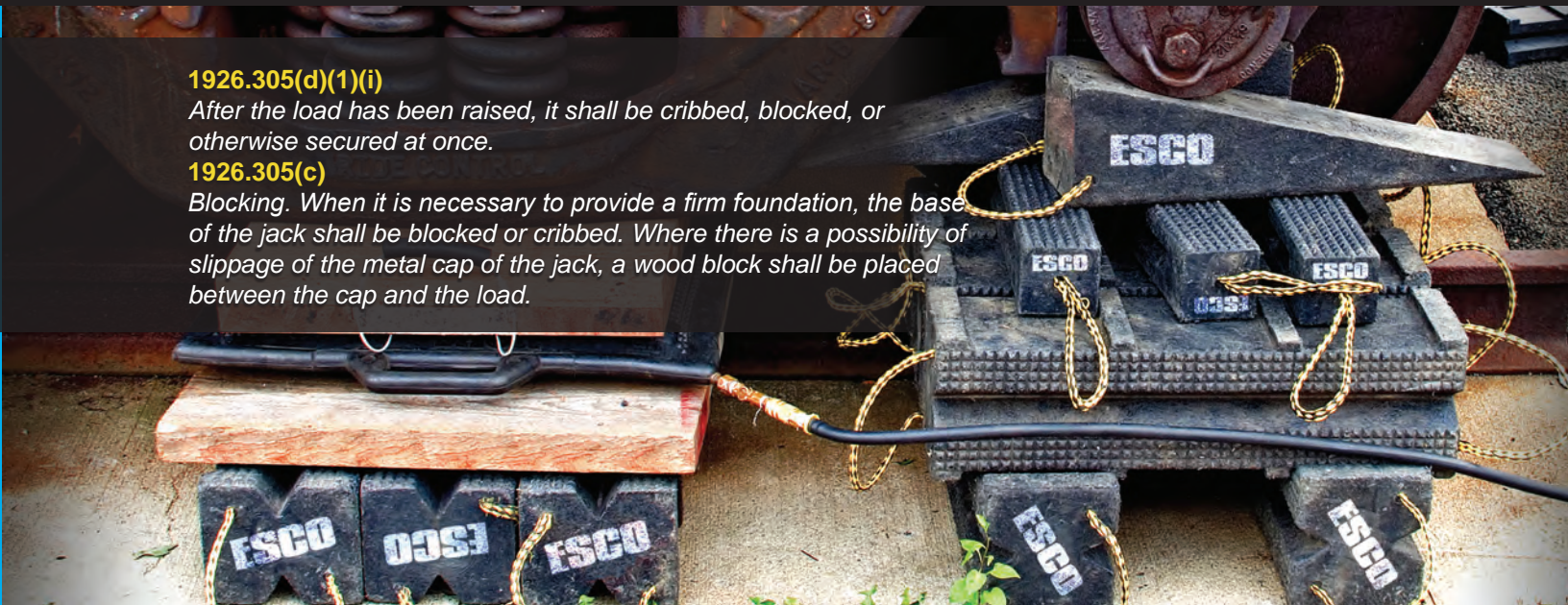

Lincoln Log Style Cribbing - Hybrid Cribbing

Model #12545

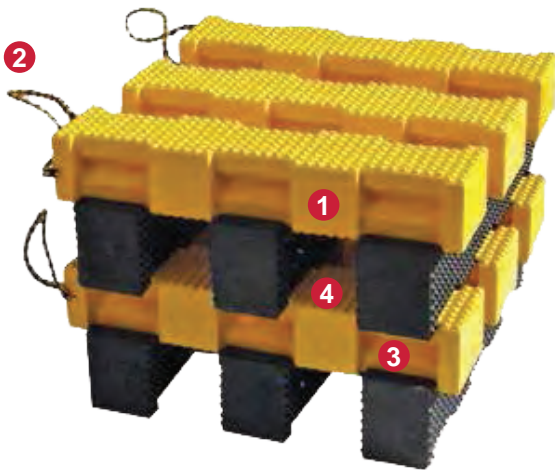

MODEL 12545

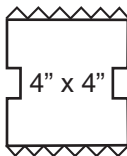

- ➊ Locking "Lincoln Log" style sides allow for additional strength and stacking configurations.
 - ➋ Built in Handle; for easy transportation
 - ➌ Inner-Locking Cribbing better sustains the load and keeps pieces from shifting.
 - ➍ Slip-resistant pyramid locking surface creates a stronger, more stable base than wood.
- ▶ 2 surfaces in one crib
 - ▶ Pyramid design securely locks at any angle
 - ▶ Three side notches interlock for secure stacking
 - ▶ Non-splitting
 - ▶ Resistant to oils, gasoline and other elements
 - ▶ Built in Lanyard
 - ▶ Cribbing Color: **Black** (Yellow Color No Longer Available)

MODEL	HEIGHT	WIDTH	LENGTH	WEIGHT
12545	4" 102mm	4" 102mm	18" 457mm	6 lbs. 3 kg

Pyramid Style Cribbing

Model #12546



MODEL 12546

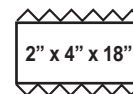

- ▶ Pyramid-locking surface on two sides.
- ▶ Built in lanyard.
- ▶ Cribbing Color: **Black** (Yellow Color No Longer Available)

MODEL	HEIGHT	WIDTH	LENGTH	WEIGHT
12546	2" 51mm	4" 102mm	18" 457mm	5 lbs. 2 kg

LARGE Pyramid Style Cribbing

- ▶ Reassurance on the largest jobs.
- ▶ Heavy duty construction
- ▶ Lanyard available.
- ▶ Cribbing Color: **Black** (Yellow Color No Longer Available)



MODEL 12549



MODEL 12555

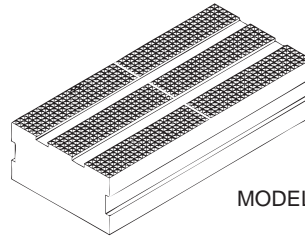

MODEL 12556

APPLICATION:
 Mining Vehicles
 Off-Road Vehicles
 Railroad
 Construction
 Oil & Gas
 And More!

MODEL	HEIGHT	WIDTH	LENGTH	WEIGHT
12549	6" 152mm	7" 178mm	24" 610mm	25 lbs. 11.4 kg
12555	6" 152mm	12" 305mm	24" 610mm	52 lbs. 23.6 kg
12556	6" 152mm	12" 305mm	12" 305mm	26 lbs. 11.8 kg



Cribbing Kits



JACK NOT INCLUDED IN KITS

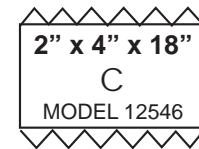
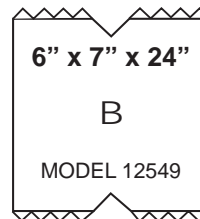
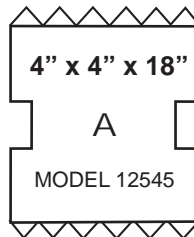

Kit #12581

	MODEL	# of Pieces
A	12549	6
B	12545	3

Kit #12582

	MODEL	# of Pieces
A	12545	3
B	12549	3

Kit #12586

	MODEL	# of Pieces
B	12549	12

Kit #12587

	MODEL	# of Pieces
A	12545	3
B	12549	3
C	12546	3

Kit #12583

	MODEL	# of Pieces
B	12549	24

Kit #12585

	MODEL	# of Pieces
B	12549	27



Bead Seaters- Air Bead Seating Tanks



5 Gallon Bead Seater
MODEL 20390



8 Gallon Bead Seater
MODEL 20391



All tanks are ASME rated. All units come equipped with **Cyclone X-Series UPGRADE Kits** with Quick Release Valve for faster and easier air release (See Accessories For More Details).

Model #	Tank Size	Material	Weight	Tank Width x Diameter
20390	5 Gallon	Steel	21 lbs. 10 kg	18" x 10" 457mm x 254mm
20391	8 Gallon	Steel	26 lbs. 12 kg	21" x 10" 533mm x 254mm

Passenger & Truck Bead Seaters



- ▶ Helps seat difficult beads.
- ▶ One-piece rubber "O" rings that fits over the rim between the tire bead and the rim flange, making a seal which allows the tire to be inflated.

Model #	Tire Sizes
20100	13-14"
20101	14-15"
20200	16.5-17.5"
20202	19.5"
20204	22.5-24.5"

Air Hoses with Clip-On and Lock-On Air Chucks



Lock on Chuck



Clip on Chuck

- ▶ Lightweight aluminum body with brass calibration bar and O-ring seals.
- ▶ Calibrated 10-120 psi in 2 lbs. Increments.
- ▶ Precise inflation/deflation control.
- ▶ 1/4" female inlet with clip-on air chuck.
- ▶ Hoses come in 6 and 12 feet.
- ▶ Lock on or Clip on Chuck Available.
- ▶ 1/4" Hose, matches up with component sizes.

Model #	Hose	Clip-On Chuck	Lock-On Chuck
10950	6 ft. 1.83mm	YES	NO
10951	12 ft. 3.66mm	YES	NO
10952	6 ft. 1.83mm	NO	YES
10953	12 ft. 3.66mm	NO	YES

2 Bar Portable Wide-Base Portable Cage - Safety Inflation Cage

Model #90408



MODEL 90408

- ▶ The portable inflation cage is often used by road service vehicles for changing and inflating tires on trucks, buses, military vehicles, etc.
- ▶ This light, compact yet sturdy inflation cage is manufactured using steel that meets the toughest standards.
- ▶ The portable inflation cage folds down to a depth of only 6" 153mm, making it very easy to stow in your service truck.
- ▶ These safety cages, a mandatory precaution for tire inflation, provide good protection and exceed the requirements of OSHA Standard 29 CFR 1910.177 in the U.S. Before using the portable inflation cage, please read the instructions carefully.

Dimensions (L x W x H)	Max. Tire Size	Weight
29" x 16 3/4" x 52" 736mm x 425mm x 1321mm	48" OD x 21" W 1219mm OD x 533mm W	73 lbs. 33 kg.

3 Bar Tire Inflation Cage - Safety Inflation Cage

Model #90409



MODEL 90409

- ▶ 3-bar tire inflation cages are used for changing and inflating tires for trucks, buses, military vehicles, etc.
- ▶ Heavy duty tire inflation cages manufactured using steel that meets the toughest standards.
- ▶ These safety cages, a mandatory precaution for tire inflation, provide good protection and exceed the requirements of OSHA Standard 29 CFR 1910.177 in the U.S. Before using the portable inflation cage, please read the instructions carefully.

Dimensions (L x W x H)	Max. Tire Size	Weight
22" x 26" x 57" 559mm x 660mm x 1448mm	54" OD x 20" W 1371mm OD x 508mm W	106 lbs. 48 kg.

4 Bar Tire Inflation Cage - Safety Inflation Cage

Model #90410



MODEL 90410

- ▶ 4-bar tire inflation cages are used for changing and inflating tires for trucks, buses, military vehicles, etc.
- ▶ Heavy duty tire inflation cages manufactured using steel that meets the toughest standards.
- ▶ These safety cages, a mandatory precaution for tire inflation, provide good protection and exceed the requirements of OSHA Standard 29 CFR 1910.177 in the U.S. Before using the portable inflation cage, please read the instructions carefully.

Dimensions (L x W x H)	Max. Tire Size	Weight
32" x 26" x 57" 813mm x 660mm x 1448mm	54" OD x 20" W 1371mm OD x 508mm W	140 lbs. 64 kg.

5 Bar Tire Inflation Cage - Safety Inflation Cage

Model #90411



MODEL 90411

- ▶ 5-bar tire inflation cages are used for changing and inflating tires for trucks, buses, military vehicles, etc.
- ▶ Heavy duty tire inflation cages manufactured using steel that meets the toughest standards.
- ▶ These safety cages, a mandatory precaution for tire inflation, provide good protection and exceed the requirements of OSHA Standard 29 CFR 1910.177 in the U.S. Before using the portable inflation cage, please read the instructions carefully.

Dimensions (L x W x H)	Max. Tire Size	Weight
41" x 26" x 57" 1041mm x 660mm x 1448mm	54" OD x 20" W 1371mm OD x 508mm W	183 lbs. 83 kg.

OTR Tire Inflation Cage - Safety Inflation Cage

Model #90412



MODEL 90412

- ▶ OTR tire inflation cage is used to inflate tires for trucks, military vehicles, tractors and aircrafts.
- ▶ Strongest Tire Cage on the market. Built with 2" 51mm steel tubing 6% larger than the competitors' tubing – welded to a 3/16" 5mm steel base with added reinforcements.
- ▶ These safety cages, a mandatory precaution for tire inflation, provide good protection and exceed the requirements of OSHA Standard 29 CFR 1910.177 in the U.S. Before using the portable inflation cage, please read the instructions carefully.

Dimensions (L x W x H)	Max. Tire Size	Weight
41" x 39" 1/2" x 68" 1041mm x 1003mm x 1727mm	62" OD x 33" W 1574mm OD x 838mm W	293 lbs. 133 kg.

Tire Inflation Cage Accessories

* DOES NOT FIT ALL MODELS. Contact ESCO representative for more details.

Inflation Cage Roller Kit*



MODEL 90414

The inflation cage roller kit is used to rotate the tires easily and without any effort directly into the inflation cage, giving you an easy access to the valve.

Automatic Tire Inflator Bracket



MODEL 90415

The automatic tire inflator stand is used to support the tire inflator directly on the inflation cage.

AUTOMATIC HD Tire Inflation Cage - 52" OD Safety Inflation Cage

Model #90422



MODEL 90422

- ▶ The heavy duty tire inflation cage is used to inflate tires for trucks, military vehicles, tractors and aircrafts.
- ▶ Specially equipped with an automatic tire inflator to make the cage even safer. You can inflate up to 195 PSI 13.5 bar.
- ▶ Equipped, on both of its doors, of a safety system that activates or deactivates the inflation of the tire. If one of the doors is open, the automatic tire inflator will not be activated.
- ▶ You must close the 2 doors properly in order to inflate.
- ▶ HD inflation cage is equipped with an air hose and a power cable (110 Volt).

Dimensions (L x W x H)	Max. Tire Size	Weight
55 11/16" x 24" x 54" 1422mm x 610mm x 1372mm	52" OD x 19" W 1287mm OD x 483mm W	578 lbs. 263 kg.

AUTOMATIC HD Tire Inflation Cage - 78" OD Safety Inflation Cage

Model #90423



MODEL 90423

- ▶ The heavy duty tire inflation cage is used to inflate tires for trucks, military vehicles, tractors and aircrafts.
- ▶ Specially equipped with an automatic tire Inflator to make the cage even safer. You can inflate up to 195 PSI 13.5 bar.
- ▶ Equipped, on both of its doors, of a safety system that activates or deactivates the inflation of the tire. If one of the doors is open, the automatic tire Inflator will not be activated. You must close the 2 doors properly in order to inflate.
- ▶ HD inflation cage is equipped with an air hose and power cable (110 Volt).

Dimensions (L x W x H)	Max. Tire Size	Weight
91" x 51" x 78" 2083mm x 1016mm x 1982mm	78" OD x 35" W 1980mm OD x 889mm W	1150 lbs. 523 kg.

AUTOMATIC HD Tire Inflation Cage - 82" OD Safety Inflation Cage

Model #90424



MODEL 90424

- ▶ The heavy duty tire inflation cage is used to inflate tires for trucks, military vehicles, tractors and aircrafts.
- ▶ Specially equipped with an automatic tire Inflator to make the cage even safer. You can inflate up to 195 PSI 13.5 bar.
- ▶ Equipped, on both of its doors, of a safety system that activates or deactivates the inflation of the tire. If one of the doors is open, the automatic tire Inflator will not be activated. You must close the 2 doors properly in order to inflate.
- ▶ HD inflation cage is equipped with an air hose and a power cable (110 Volt).

Dimensions (L x W x H)	Max. Tire Size	Weight
84" x 56" x 82" 2134mm x 1423mm x 2083mm	82" OD x 50" W 2083mm OD x 1282mm W	1324 lbs. 602kg.

AUTOMATIC OTR & Mining Tire Inflation Cage

Model #90425

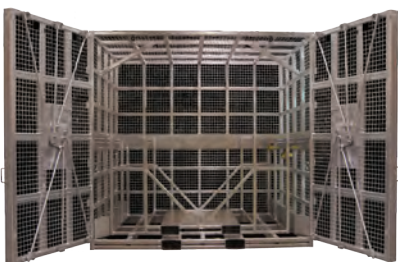

MODEL 90425

- ▶ The largest inflation safety cage ever built in the world.
- ▶ Handles tires with diameter up to 115" | 2921mm. Mining & OTR tires ranging from 24.00R49 to 45/65R/45 and even 30.00R51.
- ▶ The Cage itself weighs more than 6,500 lbs. | 2949 kg
- ▶ Hot Dipped Galvanized, this cage is manufactured to withstand temperatures ranging from - 22° F | -30° C to 122° F | 50° C.
- ▶ Equipped, on both of its doors, of a safety system that activates or deactivates the inflation of the tire. If one of the doors is open, the automatic tire Inflator will not be activated. You must close the 2 doors properly in order to inflate.
- ▶ HD inflation cage is equipped with an air hose and a power cable (110 Volt).

Dimensions (L x W x H)	Max. Tire Size	Weight
136" x 72" x 130" 3454mm x 1829mm x 3302mm	115" OD x 48" W 3000mm OD x 1219mm W	8998 lbs. 4090 kg.

Dial Gauge Tire Inflator - One Button Operation

Model #10960



100% Kink-Free
Wire Sheathed Hose



MODEL 10960

- 1 Multi-Scale Gauge - psi & bar
- 2 Wire Sheathed Hose - Eliminates Hose Kinking
- 3 Operation: Inflate, Deflate, & Measure Air Pressure
- 4 Includes: Single Straight Clip-on Style Air Chuck

- ▶ Designed with a rugged die casted body with rubber protective sleeve.
- ▶ Each unit is individually tested and calibrated (includes calibration certificate).
- ▶ Great for use in workshops, service trucks, and hobbyists.
- ▶ 3 in. | 75mm Dial Gauge.
- ▶ Air Chuck Style: Single Straight (Clip-on)
- ▶ Operation: Inflate, Deflate, Measure

Max. Inflation	174 psi 12 bar
Scale	174 psi 12 bar
Inlet Size	1/4" NPT
Hose Length	20 in. 500 mm
Weight	2.6 lbs. 0.8 kg
Accuracy	+/- 2 psi @ 25-75psi
Supply Pressure Max.	200 psi 13.79 bar

Digital Tire Inflator - Pro Series Digital Inflator

Model #10961



100% Kink-Free
Wire Sheathed Hose



MODEL 10961

- 1 Multi-Unit Measurement (PSI, Kpa, BAR)
- 2 Large Digital Display - Makes it clear to read Air Pressure
- 3 Operation: Inflate, Deflate, & Measure Air Pressure
- 4 Includes: Single Straight Clip-on Style Air Chuck
- 5 Easy Use - On/Light/Air Pressure Measurement Button

- ▶ Digital Backlit display
- ▶ Works off (2) AAA Batteries (65 hour battery life)
- ▶ Auto "Off" Function after 90-seconds.
- ▶ Each unit is individually tested and calibrated (includes calibration certificate).
- ▶ Great for use in workshops, service trucks, and hobbyists.
- ▶ Air Chuck Style: Single Straight (Clip-on)
- ▶ Operation: Inflate, Deflate, Measure

Max. Inflation	174 psi 12 bar
Scale	174 psi/ 12 bar/ 1200 Kpa/ 12kgF
Inlet Size	1/4" NPT
Hose Length	20 in. 500 mm
Weight	2 lbs. 0.8 kg
Accuracy	+/- 2 psi @ 25-75psi
Supply Pressure Max.	200 psi 13.79 bar

Pro Series Digital Tire Inflator - "Compact" One Button Operation

Model #10962



100% Kink-Free
Wire Sheathed Hose



MODEL 10962

- 1 **Multi-Scale Gauge - psi, bar, & Kpa**
 - 2 **Wire Sheathed Hose - Eliminates Hose Kinking**
 - 3 **Operation: Inflate, Deflate, & Measure Air Pressure**
 - 4 **Includes: Air Chuck Style: Dual Angle (Hold-on)**
- ▶ Large Digital LCD Screen - Easy to Read Display
 - ▶ Multi-Scale Gauge: PSI, kPa, Bar
 - ▶ 2 x AAA Batteries
 - ▶ 80 Hour Battery Life
 - ▶ Great for use in workshops, service trucks, and hobbyists.
 - ▶ Air Chuck Style: Dual Angle (Hold-on)
 - ▶ Operation: Inflate, Deflate, Measure

Max. Inflation	174 psi 12 bar
Scale	174 psi/ 12 bar/ 1200 Kpa/ 12kgF
Inlet Size	1/4" NPT
Hose Length	20 in. 500 mm
Weight	2 lbs. 0.8 kg
Accuracy	+/- 2 psi @25-75psi
Supply Pressure Max.	200 psi 13.79 bar

Automatic Handheld Tire Inflator - Rechargeable & Portable

Model #10963



MODEL 10963

The Digital Tire Inflator is a innovative design that allows for 100% Portable Automatic Inflation/Deflation. As easy as just connecting the airline, setting desired air pressure, then let the automatic inflator do the rest.

Inflator has two programable "preset" for most commonly used pressures at the push of a button. The built OPS (Over Pressure Setting) is a great safety feature that allows for the technician to set the pressure and walk away; ideal for mobile service trucks that deal with truck, car, earthmover, and more.

- 1 **Multi-Scale Gauge: PSI, bar, kPa, kgF**
- 2 **Wire Sheathed Hose - Eliminates Hose Kinking**
- 3 **Operation: Inflate, Deflate, & Measure Air Pressure**
- 4 **Tough Poly Carbonate Construction - For Heavy Duty Use**

- ▶ Includes Calibration Certification
- ▶ Large Backlift Digital Display
- ▶ Tough Poly Carbonate Construction
- ▶ Air Chuck Style: Single Straight (Clip-on)
- ▶ Supply Voltage: DC 12V Rechargeable Battery (Li-ion)
- ▶ Wattage: 12W Maximum
- ▶ Battery Life: 15 Hours (fully charged continuous use)
- ▶ Includes: Inflator, Hose, Instruction Manual and AC Charger.

Scale	174 psi/ 12 bar/ 1200 Kpa/ 12kgF
Inlet Size	1/4" NPT
Hose Length	5 ft. 1.5 m
Weight	4.5 lbs. 2 kg
Accuracy	+/- 0.3 psi @25-75psi
Supply Pressure Max.	182 psi 12.55 bar

AVAILABLE ACCESSORIES:

Four-Way Manifold and (4) Hoses (6 ft. Hoses) & Inflation Unit

MODEL 10963-K

Inflate up to four tires at once all at the preset air pressure. Great for Mobile Service Fleets.

Four-Way Manifold and (4) Hoses (6 ft. Hoses) ONLY

MODEL 10966



MODEL 10963-K

Warning: Air pre-filters must be used with this inflator to ensure product accuracy & longevity

Digital Wall Mounted Tire Inflator - Wall Mountable Inflation System

Model #10964



MODEL 10964

- 1 Wall Mountable Auto Air Inflation System
- 2 Heavy Duty Metal Housing
- 3 Large Backlit LCD Display with Audible Warning
- 4 32 ft. Single Straight (Clip On) Air Hose Included

- ▶ Programable Pre-Set Functions (P1 & P2) for quick use with common inflation values.
- ▶ Comprehensive Diagnostics & Error Reports
- ▶ Inflates accurately with hose length up to 165 ft | 50 m
- ▶ Operation: Inflate, Deflate, & Measure Air Pressure
- ▶ Advised Application: Indoor Industrial, Workshops
- ▶ Supply Voltage: 110V
- ▶ Wattage: 12 W Max.

Max. Inflation	174 psi 12 bar
Scale	174 psi/ 12 bar/ 1200 Kpa/ 12kgF
Inlet Size	1/4" NPT
Hose Length	32 ft. 10 m
Weight	4.6 lbs. 2.3 kg
Accuracy	+/- 0.3 psi @ 25-75psi
Supply Pressure Max.	182 psi 12.55 bar

Digital Wall Mounted Tire Inflator - Wall Mountable Inflation System

Model #10965



MODEL 10965

Standard inflate/deflate (auto) - Over pressure for Tire shops; where new tires are fitted and you need to ensure that the tire inflates to a pressure where the tire seats properly on the rim then deflates automatically to the required preset pressure.

Flat Tire: where there is no residual tire pressure in the tire the inflator does not automatically start so a manual override is required to fill flat tires.

Built tough to last this unit is IP56 rated so it can withstand the elements inside and out, it has mechanical anti-vandal buttons and a loud audible warning that can be heard in the noisiest areas when the correct Tire pressure has been reached.

- ▶ Aluminum Die-Cast Housing
- ▶ Mechanical Anti-Vandal Buttons
- ▶ IP56 Rated for Indoor and Outdoor Use
- ▶ OPS System - Audible Warning
- ▶ Comprehensive Diagnostics and Error Reporting
- ▶ Will Inflate Accurately with Hose Lengths up to 164 ft. Long

Wall Mounted Tire Inflation System w/ 4-Hose Manifold*



*For Manifold Only w/ (4) 25' Hoses- Model 10967

Chuck type	Clip on
Chuck style	Single straight
Scale	0-145 psi, 0.5-10 bar, 0-1000 kPa
Inlet size	1/4" NPT female
Hose length	25 ft. 7.5 m
Weight	12 lbs. 5.5kg
Accuracy*	+/- 0.3 psi @ 25-75 psi
Operation	Auto Inflate, Deflate
Supply pressure max.	182 psi
Advised application	Industrial, workshops, outdoor
Supply voltage	110V
Wattage	12 W Max.
Humidity range	Up to 95% RH non condensing
Inflation speed	106 cfm 3000 L/ min @ 182 psi

Pro Series Air Hose Reel - 65 ft. Extreme UltraFlex Hose Included

Model #10970

NEW!



EXTREME
ULTRAFLEX
REINFORCED HOSE

MODEL 10970

- ▶ Auto lock / auto rewind
- ▶ Hose layering system
- ▶ Solid brass internal spindle
- ▶ High impact tough and durable polypropylene construction with a UV stabilised case
- ▶ 180° swivel wall mount bracket
- ▶ Leader hose 6.5 ft. with brass fittings
- ▶ Adjustable hose stop

Hose I.D.	3/8 in. 9.2mm
Hose O.D.	1/2 in. 15.2mm
Leader Hose Length	6.5 ft. 2 m
Hose Material	Rubber & PVC Blended
Reel/Case Type	Retractable/Polypropylene
Auto Lock/Auto Rewind	Yes
Max Working Pressure	300 psi 2068 kPa
Fitting Size	1/4" NPT male brass swivel
Weight	18.7 lbs. 8.5 kg

Pro Series Air Hose Reel - 25 ft. Extreme UltraFlex Hose Included

Model #10971

NEW!



EXTREME
ULTRAFLEX
REINFORCED HOSE

MODEL 10971

- ▶ Auto lock / auto rewind
- ▶ Hose layering system
- ▶ Brass fittings
- ▶ High impact tough and durable polypropylene construction with a UV stabilised case
- ▶ 180° swivel wall mount bracket
- ▶ Leader hose 3.25 ft. with brass fittings
- ▶ Adjustable hose stop

Hose length	25 ft. 8 m
Hose I.D.	3/8 in. 9.2mm
Hose O.D.	1/2 in. 15.2mm
Leader hose length	3.25 ft. 1 m
Hose Material	Extreme UltraFlex Reinforced Hose
Reel Case/Type	Retractable/Polypropylene
Auto Lock/Auto Rewind	Yes
Max. working pressure	300 psi 2068 kPa
Fitting size	1/4" NPT Male Brass Fitting
Weight	8.8 lbs 4 kg

EXTREME UltraFlex Air Hose - 3/8" ID Professional Air Hose for Shops & More...

EXTREME ULTRAFLEX REINFORCED AIR HOSE is specially designed hose that has been developed to cater to today's high demand conditions and use. It stays **FLEXIBLE** in the **COLD** and does not **KINK** in the **HEAT**. This allows for full flow in all weather conditions.

- ▶ A Tough Hose for Tough Conditions
- ▶ UV Stabilized Material
- ▶ Compressed Air Application (up to 300 psi)
- ▶ Available in (3) Different Size Lengths

EXTREME
ULTRAFLEX
REINFORCED HOSE

Model #	10972	10973	10974
Hose Length	30 ft. 10 m	65 ft. 20 m	100 ft. 30 m
Type	1/4 in. NPT Male	1/4 in. NPT Male	1/4 in. NPT Male
Inner Diameter	3/8 in. 9.2 mm	3/8 in. 9.2 mm	3/8 in. 9.2 mm
Outer Diameter	1/2 in. 15.2 mm	1/2 in. 15.2 mm	1/2 in. 15.2 mm

NEW!



EASYWAY - "The Original" Tubeless Truck Tire Demounting System

Model #70100



Point.Scan.Explore.



MODEL 70100

- 1 Pivoting Design - Simple Demounting of First Bead
- 2 Designed for Easy Placement onto Second Bead
- 3 Leverage Handle
- 4 Rim Protector - Eliminate Scratching of Rim.

- ▶ Demount tubeless truck tires in 8 Seconds.
- ▶ Removes top and bottom bead from one side.
- ▶ Never lift tire to demount rear or bottom.
- ▶ Eliminates bead damages.
- ▶ Tough cast ductile iron.
- ▶ Handles all tubeless truck tires 16.5"-24.5" diameter
- ▶ Works on some Super Single "floats"
- ▶ No Damage to Aluminum Wheels.
- ▶ Weight: 37 lbs. | 17 kg



Tyr-X Truck Tire Demount Tool- All in One System for Tubeless Truck Tires

Model #20396



MODEL 20396

Point.Scan.Explore.



- 1 Curved Design for Positioning Tool - Easy Grabbing of First Bead
- 2 The Bearing Pivot Joint Demounts the Second Bead with Ease
- 3 Curved Design for Better Leverage when Using Tool

- ▶ The **Tyr-X Truck Tire Demounting Tool** is a safe, quick, and reliable tire demounting tool that makes tire demounting a simple process.
- ▶ The pivot hooks ensure easy and positive operation. Its design eliminates aggressive stretching of the tire bead.
- ▶ One of the easiest and fastest manual truck tire demounting tool on the market.
- ▶ Works on standard truck tires (22.5-24.5) and can be used for the first bead of super singles or double wide truck tires.
- ▶ Weight: 17 lbs. | 8 kg



Truck Tire Kit

MODEL 20416

- KITS:**
- #20396 - Tyr-X Demounting Tool
 - #20401 - Single Sided HD Mounting Bar
 - #20406 - Pair of HD Bead Holders
 - #20397 - HD Bead Wedge



MODEL 20416

Tyr-X Tool demounts both top bead and bottom bead from short side of rim. No need to flip the tire/rim assembly.

ESC100 - Truck Tire Demounting Tool

Model #90518-100-1



MODEL 90518-100-1



- ▶ Removes both top and bottom bead from short side - no need to flip tire/rim.
- ▶ Demount all tubeless tires 17.5" through 24.5" & Super Singles up through 315/22.5"
- ▶ Including most radial and bias ply tires.
- ▶ Demounts tire in 8 seconds.
- ▶ Weight: 26 lbs. | 11.8 kg

ESC100 Kit- Truck Tire Demount & Mounting Tool Kit

Model #90518-100-KIT



MODEL 90518-100-KIT

- ▶ ESC100 - Demount Tool
- ▶ ESC200M - Mounting Tool
- ▶ 70141 - Truck Tire Bead Holder
- ▶ Kit Weight: 37 lbs. | 16.8 kg

Point.Scan.Explore.



ESC200- Truck Tire Demounting Tool - For Super Singles

Model #90518-200-1



MODEL 90518-200-1



- ▶ Removes both top and bottom bead from same side - no need to flip tire/rim.
- ▶ Demount tires 17.5" to 24.5" & Super Singles 215 through 445.
- ▶ Including most radial and bias ply tires.
- ▶ Ideal for demounting 445 X 22.5 tires.
- ▶ Weight: 23 lbs. | 10.4 kg

ESC200 Kit- Demounting & Mounting Kit - For Super Singles

Model #90518-200-KIT



MODEL 90518-200-KIT

- ▶ ESC-200M - Mounting Tool
- ▶ ESC-200-1 - Demounting Tool
- ▶ 70141 - Truck Tire Bead Holder
- ▶ Weight: 33 lbs. | 15 kg

Point.Scan.Explore.



Single Sided Mounting Bar - For Large Tires

Model #20401



MODEL 20401

- ▶ Mounting bar with unique bends which improve tool insertion, leverage and bead pressure.
- ▶ Weight 6 lbs. | 3 kg

Double Sided Mounting Bar - Designed for 19.5 Tires

Model #20402



MODEL 20402

- ▶ Double sided short mounting bar allows for all of the above but is designed for the hard reverse hub wheels.
- ▶ Weight: 4 lbs. | 2 kg

Specialty Truck Tire Mounting Bar - Designed for 17.5 & 19.5 Reverse Hubs

Model #20430



MODEL 20430

- ▶ Works on 24.5" Tires and Smaller
- ▶ The Unique design of the mounting lip allows you to work around the hub for mounting reverse hub 17.5 and 19.5 rim combinations.
- ▶ Small design aids in not damaging the tire bead by eliminating "large bites" when mounting tire onto wheel.
- ▶ Weight: 5 lbs. | 2.5kg

ESC200M- Truck Tire Mounting Tool

Model #90518-200M



MODEL 90518-200M

- ▶ Mount all tubeless tires 17.5" through 24.5"
- ▶ Mounts tire in 20 seconds.
- ▶ Weight: 11 lbs. | 5 kg

HD 35" Mounting Bar - Good for Mounting Tires on Tire Machine

Model #20403

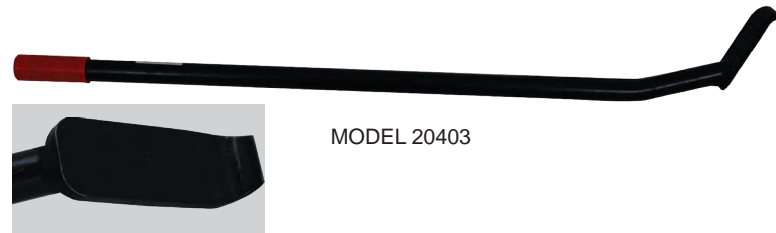

MODEL 20403

- ▶ The #20403 is a shorter 35" heavy duty mounting bar that makes it easier to handle when mounting on the machine or in a vertical position.
- ▶ Weight: 6 lbs. | 3 kg

HD 52" Mounting Bar- Longer Design/For Better Leverage

Model #20404

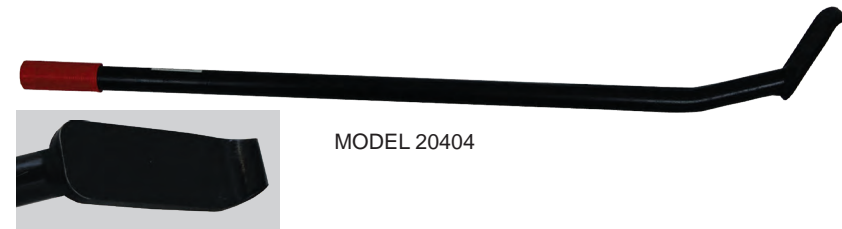

MODEL 20404

- ▶ The #20404 is a longer 52" heavy duty mounting bar that gives you more leverage when mounting in a horizontal position on the ground.
- ▶ Weight: 8 lbs. | 4 kg

Truck Tire Bead Holder - Coated to protect rim from damage

Model #70141



MODEL 70141

- ▶ Keeps truck tire bead from slipping during mounting of top bead.
- ▶ Use 2 bead holders – no need to stand on tire to mount.
- ▶ Made with rubber coated metal.
- ▶ Will not scratch aluminum wheels.
- ▶ Great for hard to mount tires.
- ▶ Weight: 3 lbs. | 1.4 kg.

Agricultural Tire Bead Holder - Uniquely Designed “Flip-Handle”

Model #20405



MODEL 20405



- ▶ Designed for use on agricultural, tractor tires.
- ▶ Unique design allows for bead to be positioned onto rim with “Flip-Handle”.
- ▶ Lightweight and Easy to use.
- ▶ Weight: 5 lbs. | 2.25 kg

Bead Holders - Two-Piece Bead Holders For Commercial Truck Tires

Model #20406



MODEL 20406



- ▶ Commercial Truck Bead Holders act as an extra set of hands.
- ▶ Removes the need to “Walk” on the tire while mounting the tire back onto the rim.
- ▶ Polymer plastic tips protect rims from being scratched.
- ▶ Sold as a Pair
- ▶ Weight: 3 lbs. | 1 kg

Specialty Truck Tire Demounter - Pneumatic Demount Tool for Superwides

Model #20418



MODEL 20418

- 1** Extension Foot - For Bead Grabbing & Dismounting.
 - 2** Hook to Use As Leverage to Pull Rim Out from Tire without Using Force or Labor 1/16” Pneumatic Drive
 - 3** 1 1/16” Pneumatic Drive
 - 4** Maximum Extension Foot - 15” | 381 mm
 - 5** Optional Removable Handle - For Better Positioning and Setting of Tool onto Rim/Tire
- ▶ Safe, Easy and Fast way to demount the second bead on a wide range of tires with difficult stiff sides.
 - ▶ Works Great for Sprinkler and Off-Road Super Single Float Tires.
 - ▶ Pulls Wheel Off of the Tire.
 - ▶ Built to be used on tough Superwides.
 - ▶ Can be used to mount first bead on tougher tires.
 - ▶ 100% Pneumatic Tool – Can be used with Impact Gun
 - ▶ Lightweight and build strong to withstand constant use.
 - ▶ Weight: 15 lbs. | 6.8 kg

Universal Impact Driven Demounter - Pneumatic Tire Demount Tool

Model #20408



- 1 Patented Designed Bead Grasping Heel
- 2 Extension Foot - For Bead Grabbing & Dismounting
- 3 1 1/16" Pneumatic Drive
- 4 Leverage Handle to aid in better Positioning of Tool

- ▶ Safe, Simple, Fast and Economical
- ▶ Most Universal Tire Demounter on the Market.
- ▶ Works as a **Hand-Held Tire Machine** and shines where other tools fall short.
- ▶ Tackles the Hard 19.5 Reverse Hubs and Grader Tires.
- ▶ Can be used on ALL Tire sizes from 10" ATV Tires and Up.
- ▶ Great for Agricultural Tires, One-Piece Grader, Loader, Forestry and Back Hoe Tires.
- ▶ Come with 1 1/16" Socket
- ▶ Replaceable Rim Protector (see parts section page 96 for details)
- ▶ Weight: 24 lbs. | 10.9 kg

Point.Scan.Explore.



MODEL 20408



MODEL 20414



MODEL 20415A



MODEL 20415

Small Truck Tire Kit

MODEL 20414

- #20408 - Universal Demounter
- #20402 - Double Sided Mounting Bar
- #20406 - Pair of HD Bead Holders
- #20397 - HD Bead Wedge



Agricultural Tire Kit

MODEL 20415A

- #20408 - Universal Demounter
- #20404 - 35" Mounting Bar
- #20403 - 52" Mounting Bar
- #20405 - Agricultural Tire Bead Holder



Large Truck Tire Kit

MODEL 20415

- #20408 - Universal Demounter
- #20404 - 35" Mounting Bar
- #20403 - 52" Mounting Bar
- #20406 - Pair of Bead Holders



HD Bead Wedge - Keeps the Tire in Drop Center when Demounting Tire

Model #20397



MODEL 20397



- ▶ Puts tire in drop center
- ▶ Bead Wedge guides tires with stiffer side walls when demounting tires
- ▶ Reduces bead damage and stretching
- ▶ Recommended to be used with Model 20408 Universal Tire Demount Tool or Any Other Truck Tire Demounting Applications.
- ▶ Weight: 2 lbs. | 0.91 kg

OSHA

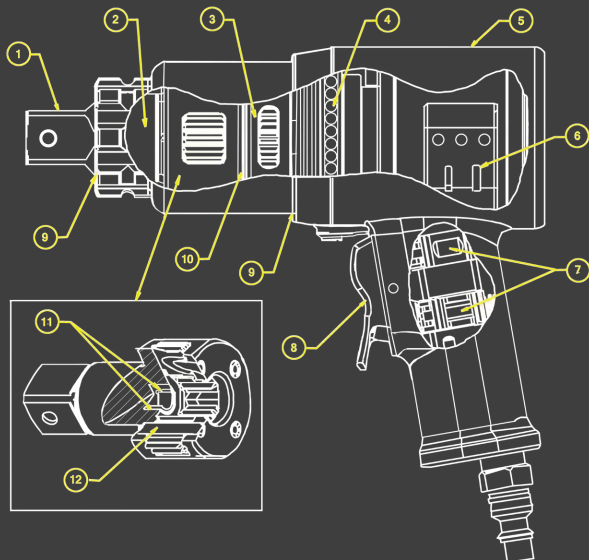

1. Hardened alloy steel for durability and long cycle life
2. Bearings support the loads experienced at the square drive
3. Multiple stage planetary gear systems with optimized tooth design
4. Smooth ball bearing rotation of the gearbox housing independent from the motor handle
5. Lightweight aluminum handle with durable, slip-resistant textured coating
6. Ultra-efficient air motor designed for easy maintenance
7. Cartridge-style valves provide easy replacement
8. One finger trigger control for forward and reverse
9. O-rings seal grease in while keeping water and dirt out
10. Thrust bearing between stages isolate the motor when used in all orientations
11. Gears run on low friction, high strength bearing sleeves
12. Chrome steel pins in each gear stage.

ADD ON EXTENSIONS FOR TORQUE WRENCHES

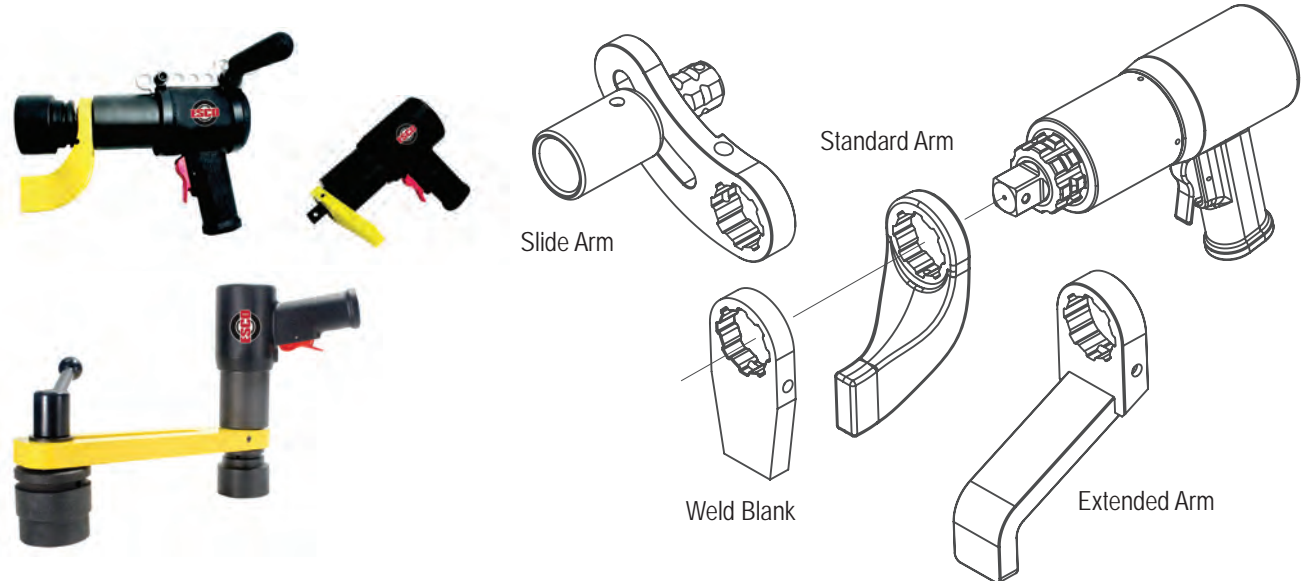

Pneumatic Torque Wrenches- Specifications & Models

OSHA

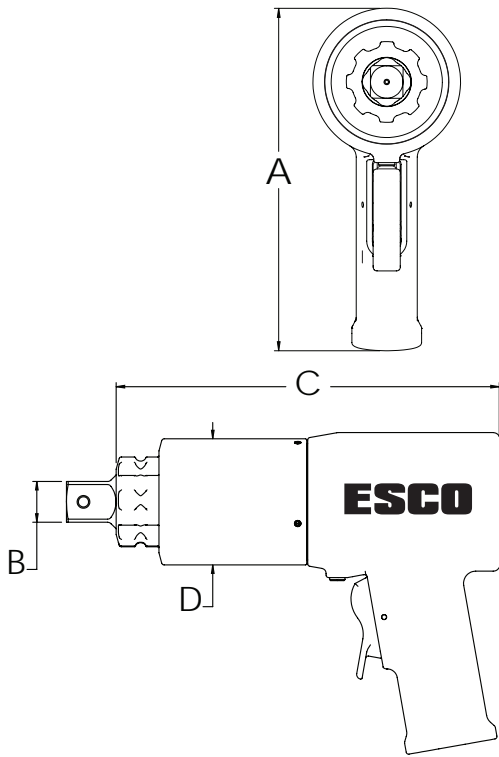

MODEL NUMBER	10002	10024	10001	10015	10017
Square drive	3/4"	1"	1"	1"	1 1/2"
Min. Torque (Ft/Lbs)	130	300	460	1005	1525
Max. Torque (Ft/Lbs)	530	1030	2015	3070	5990
Min. Torque (Nm)	176	407	624	1362	2067
Max. Torque (Nm)	718	1396	2732	4162	8120
Dimension A (in)	7.89"	7.89"	7.89"	8.06"	8.69"
Dimension A (mm)	200.4	200.4	200.4	204.7	220.7
Square Drive B (in)	0.75"	1"	1"	1"	1.5"
Square Drive B (mm)	19.05	25.4	25.4	25.4	38.1
Dimension C (in)	6.80"	8.87"	9.40"	10.62"	12.32"
Dimension C (mm)	172.7	225.3	238.8	269.7	312.9
Diameter D (in)	2.56"	2.85"	3.09"	3.75"	5.00"
Diameter D (mm)	65.0	72.4	78.5	95.3	127.0
Weight (Lbs)	9	12	16	20	36
Weight (Kg)	4.1	5.5	7.3	9.1	16.3
Performance Data (RPM)					
- RPM @ 20 psi	26	11	6	3	2
- Tool Max psi	80 psi	70 psi	90 psi	65 psi	90 psi
- RPM @ MAX psi	44	15	9	4	3



#10002 **single speed**
Torque range 130-530
Free speed 26-44 RPM

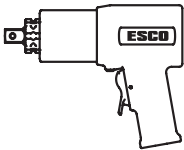

#10024 **single speed**
Torque range 300-1030
Free Speed 11-15 RPM

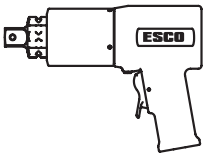

#10001 **single speed**
Torque range 460-2015
Free speed 6-9 RPM

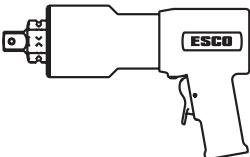

#10015 **single speed**
Torque range 1005-3070
Free speed 3-4 RPM

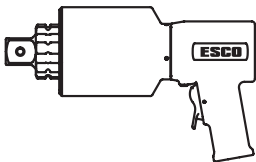

#10017 **single speed**
Torque range 1525-5990
Free speed 2-3 RPM

ESCO Pneumatic Torque Wrench Kit - for HD Truck

- ▶ Extremely Accurate: Consistent Torque.
- ▶ Values +/- 5%
- ▶ Drive Size: 3/4", 1", & 1,5"
- ▶ Comes with a Heavy Duty Carrying Case.
- ▶ Range of Torque: 150 - 1000 ft lbs.
- ▶ Reversible - One Tool Does it All:
- ▶ Powerful Nut Removal / Precision Torque On.
- ▶ Designed to Torque Various Ranges of Wheel
- ▶ Types and Sizes.
- ▶ **Made in the USA**
- ▶ Lightweight Gun: 16 lbs. 7 kg
- ▶ Total Weight: 38 lbs. 17 kg

MODEL 10006
Pneumatic Torque Wrench Kit for HD Truck



MODEL 10004 Air Regulator & Hose
Included with Model 10006 Kit

Break-Back Style Torque Wrenches - 3/4" & 1" Drives

OSHA



- ▶ Quality Made and Precision
- ▶ The Large Break Angle Improves Accuracy By Reducing The Possibility Of Over Torquing
- ▶ Cam Control Of The Mechanism Gives A Controlled Break Which Will Not Throw The Operator Off Balance
- ▶ Extremely High Accuracy: Consistent Torque Values +/- 4%
- ▶ Easily Set an Infinite Range of Torque Values
- ▶ Prevents Damage: Won't Allow Over Torquing
- ▶ Designed to Torque a Complete Range of Wheel Types and Sizes
- ▶ Use on Single & Dual Wheels
- ▶ Comes with Molded Carrying Case

Specifications:

Models	Square Drive	Range N.M	Range ft lb	Ratchet Diameter	Length	Weight
10007	3/4"	300-1000	200-750	2 3/4"	57" 1448mm	27 lbs 12 kg
10010	1"	300-1000	200-750	2 3/4"	57" 1448mm	30 lbs 14 kg

Break-Back Style Torque Wrench Extensions

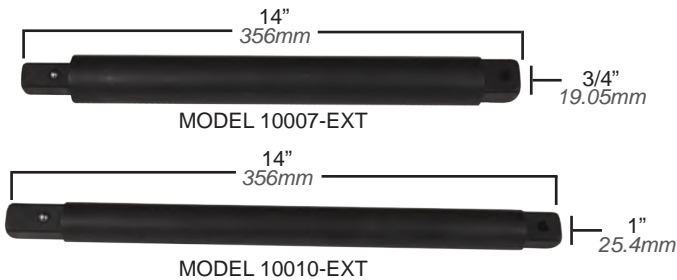

Universal Break-Back Style Torque Wrench Kit



MODEL 10021

- ▶ Kit includes 3/4" & 1" Square Drive
- ▶ Comes with Molded Carrying Case
- ▶ Combination of ESCO #10007 & #10010 Torque wrenches for multiple application and usability.

EZBUSTER - Manual Nut Loosening Tool

Model #60305



MODEL 60305

- ▶ Designed to loosen over-torqued, rusted, or corroded nuts from the wheel face/stud.
- ▶ Great for use on Agricultural wheels, Commercial Truck, & More.
- ▶ 2,800 ft. lbs. of torque
- ▶ Gear Ratio: 58:1
- ▶ Comes with 32mm & 33mm Sockets
- ▶ Weight: 18 lbs. | 8 kg

Point.Scan.Explore.



EZ Handle used to fully remove nuts from the stud after loosening the nut.



33mm & 32mm Sockets INCLUDED

Skirt Nut - Replaces Standard M22 Flange Nuts

Model #40125



MODEL 40125

- ▶ **STOPS** Wheel/Hub Vibrations and Many Tire Wearing Problems.
- ▶ **NO MORE LOOSE WHEELS** Stops Wheel Movement (Clocking) on the face of the Hub.
- ▶ **ELIMINATES WASTED FUEL** caused by rolling resistance "Drag".
- ▶ **MEETS AND EXCEEDS** Standards of SAE J1965 for Torque Tension.
- ▶ Replaces **ALL** style M22 Flange Nuts on Hub-Piloted Wheels
- ▶ Hex: 33 mm.
- ▶ Special Graphite Coating Prevents Nut from Rusting onto Hub.
- ▶ Fills in the Gap between the stud and the bolt 3/16" | 5mm



Point.Scan.Explore.



ESCO Skirt Nut Available packaged in 10 pcs. & 100 pcs. Perfect for any store set up and/or for "PER WHEEL" Application.

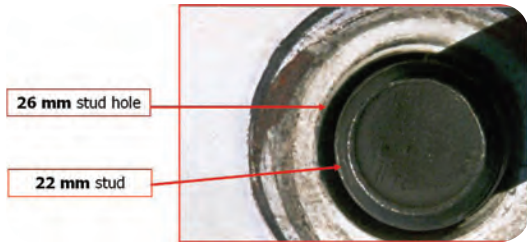

There is a fairly large tolerance between the diameter of each stud hole and the diameter of the stud itself



MODEL 40125-T



MODEL 40125-100

Dual Wheel Application:

Standard flange nuts clamp against the disc surface only; DOES NOT eliminate extra space between stud and stud holes.

VS.

Each Skirt Nut clamps against the disc surface; self-centers, AND DOES eliminate extra 4mm space between stud and stud holes - No "Clocking" is permitted.

Skirt Nut's Flange washer takes over 2,500 lbs. of force to pop off the nut which is 50 times more than standard flange washers!

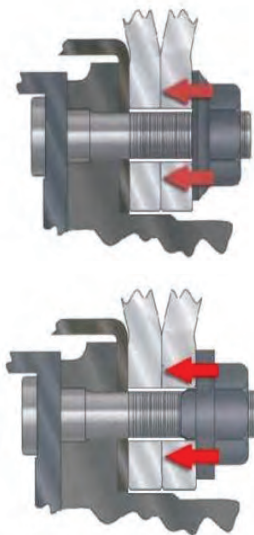

REMINDER: To Maintain Correct Clamping Force, Improve Tire Wear and Eliminate the risk of Wheel Loss, **10 Skirt Nuts per wheel are Required...**

WHEEL-TITE - SLEEVE NUTS FOR STUD PILOTED WHEELS



19.5mm

MODEL 40130



28mm

MODEL 40131



39.5mm

MODEL 40132

- ▶ STOPS WHEEL CLOCKING
- ▶ Reduces the risk of wheel offs
- ▶ Lowers maintenance costs
- ▶ Ride improves and wear factors are reduced.
- ▶ Suspension life improves as a result of reduced wheel vibration.
- ▶ Eliminates wheel-to-hub misalignment
- ▶ Decrease erratic tire wear.

Model #	Thread	Sleeve Length	Application
40130	22mm	19.5mm	Aluminum STEERS/Steel DRIVES or Steel Outer/Aluminum Inner Drive Combination
40131	22mm	28mm	Heavy Duty Aluminum & Super Single - Wide Base
40132	22mm	39.5mm	DRIVE Axle Wheels Dual Aluminums

EXTENDED SLEEVES FOR DUAL WHEEL APPLICATION

ELIMINATE: Clocking & Wheel Offs

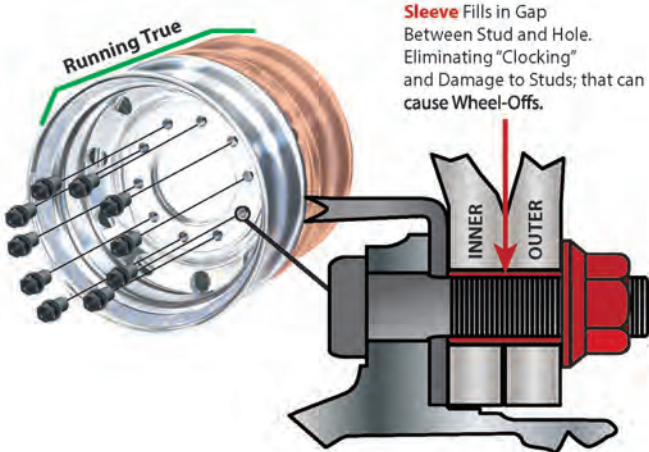

Clocking of rims causes thread damage and stress risers in studs which can lead to premature stud failure (untouched photos)

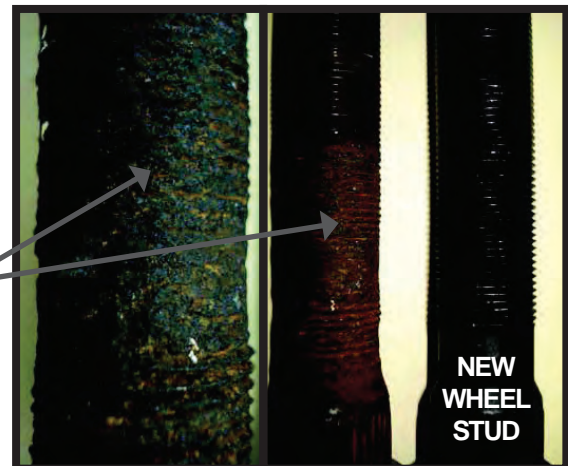

Rethread Kit - Simple & Fast Rethreading Kit

Model #30100



MODEL 30100

Today's complex disc brake, four wheel drive, and front wheel drive vehicles make replacing damaged wheel studs a costly job; This cost must frequently be absorbed. If the rotor becomes bent or warped during stud replacement, then it must be turned; If you turn one rotor, then you must also turn the other one. Damaged studs can be renewed in minutes without removing the caliper, rotor, or stud.

- ▶ A 30-second solution to an hour-long job.
- ▶ Solves the problem of removing and replacing damaged wheel studs.
- ▶ **Lifetime guarantee.**
- ▶ Individual sizes also available.

SIZES:	7/16"	1/2"	9/16"	5/8"
	12mm - 1.25"	12mm - 1.5"	14mm - 1.5"	

Save-A-Stud Plus - The Best Way to Fix Damaged Threads

Model #30120



MODEL 30120

A 30-second solution to an hour-long job. Repairs wheel studs, spindles, and standard threaded studs. Damaged studs can be renewed in minutes without removing the caliper, rotor, or stud.

- ▶ Restore don't replace.
- ▶ The best way to fix damaged threads.
- ▶ Unique, patented hinged design (instead of two separate halves)
- ▶ **Lifetime guarantee.**
- ▶ Unit comes complete with a plastic carrying case.

SIZES:	9/16 - 18	5/8 - 18	14mm - 1.50	14mm - 2.0	
	7/16 - 20	1/2 - 20R	12mm - 1.25	12mm - 1.5	12mm - 1.75

Save-A-Stud Plus + - Truck/Trailer Rethread Kit

Model #30121



MODEL 30121

- ▶ Similar to Model #30120 Save-A-Stud Kit
- ▶ Rethreads Truck and Trailer Studs / U-Bolts
- ▶ Five Piece Kit
- ▶ Unit comes complete with a plastic carrying case
- ▶ **Lifetime guarantee.**

SIZES:	1 1/8" - 16 LEFT	1 1/8" - 16 RIGHT	
	3/4" - 16 LEFT	3/4" - 16 LEFT	22mm-1.50

Save-A-Stud Plus HD - For Heavy Duty Truck

Model #30125



MODEL 30125

- ▶ Similar to the 30120 Save-A-Stud kit.
- ▶ 22mm Studs & Inner Wheel Nut Right & Left Outer Threads.
- ▶ Three Piece Kit.
- ▶ Unit comes complete with a plastic carrying case.
- ▶ Sizes: 3/4" - 16" RIGHT, 3/4" - 16" LEFT, 22 - 1.5 mm

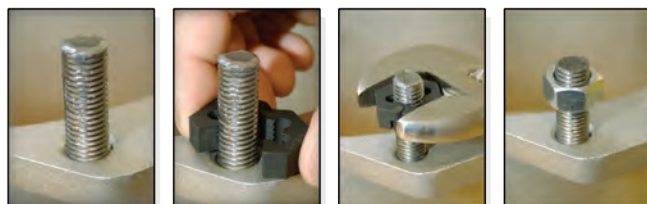

Chrome Nut Pliers *DELUXE*

Model #50100



MODEL 50100

- ▶ Extra tough material will not wear out.
- ▶ No adjustment needed, fits all size chrome nut covers 1/2" to 1 7/8".
- ▶ Won't break or collapse.
- ▶ Best pliers in the industry.
- ▶ Use soft head to hammer nut covers onto nuts.

No Mar Valve Stem Puller- *No Scratches or Marring of Chrome*

Model #50103



MODEL 50103

- ▶ Will not mar or scratch expensive chrome and alloy wheels.
- ▶ Made of composite plastic materials.
- ▶ Install and remove tubeless valves in seconds.
- ▶ Easy to use- won't bend or break and is long lasting.
- ▶ Metal tip helps push out old snap-in valve.

Valve Stem Installer - *Heavy Duty Polymer Coating - Long Lasting*

Model #50114



MODEL 50114

- ▶ Heavy Duty polymer coating lasts for thousands of uses.
- ▶ Snap-in valve mounting tool.
- ▶ Bent design for easier access of all valves.

Valve Stem Puller - *Plastic Screw Style*

Model #50117



MODEL 50117

- ▶ Plastic screw on type.
- ▶ Will not scratch or mar aluminum wheels.
- ▶ Durable plastic has long life.
- ▶ Model 50117 has metal rod inserted for extra strength.
- ▶ Metal rod will not break.

Wheel Weight Plier - *Soft Head Style*

Model #50121



MODEL 50121

- ▶ Deluxe unit.
- ▶ Soft head will not damage aluminum or mag wheels.
- ▶ Nickel chrome plated.
- ▶ Red PVC coated handles.

GOAT Wheel Weight Tool - Multi-Wheel Weight Tool

Model #50128



- 1 Replaceable Polymer Hammer Cap
 - 2 Specially Designed Hook to Remove Any Style Wheel Weight.
 - 3 Non-Slip Grip - Won't "Bite" Hand while in-use.
 - 4 Wheel Weight Trimmer (Replaceable)
- ▶ The Only Heavy Duty Wheel Weight Plier/Hammer Tool on the Market for All Wheel Weights: FAST & EASY!
 - ▶ Install, Remove, Reshape, & Trim Wheel Weights with One Simple Tool.
 - ▶ Will Not Scratch or Scar the Wheel - No-Mar Design.
 - ▶ Ergonomically Designed Tool - Rubber Coated Handle for Strong and Comfortable Grip.



MODEL 50128



Point.Scan.Explore.



GOAT Wheel Weight Tool - Replacement Parts

Replacement Cap



MODEL 50128-1

Replacement Boot

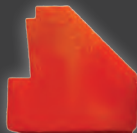

MODEL 50128-2

Replacement Grip(s)



MODEL 50128-3

Replacement Hook



MODEL 50128-5

Replacement Kit



MODEL 50128-KIT

Wheel Weight Hammer - Passenger Style

Model #50122



MODEL 50122

- ▶ Passenger Wheel Weight Hammer.
- ▶ Drop forged chrome vanadium steel.
- ▶ Hardened and tempered for longer life.
- ▶ Red coated handle fully cover plier; no sharp edges.

Wheel Weight Hammer

Model #50147



MODEL 50147

- ▶ Soft head wheel weight hammer is ideal for hammering coated wheel weights.
- ▶ Claw hook is replaceable, model 50147H.

Adjustable Tire Wheel Dolly - Capable of handling a wide range of tires

Model #70134

NEW!

OSHA



MODEL 70134

- 1 Ergonomically Designed Handle: Shaped for Ideal Balance and Positioning.**
- 2 9.625" Adjustable Rollers for a much wider range of tire sizes. 3.15" of adjustability per Roller.**
- 3 Dual-Wheel Design allows for better positioning & movability of the unit.**
- 4 Positioning wheels to rotate tire on dolly with ease.**
 - ▶ Easy removal and installation of truck tire/wheel assemblies.
 - ▶ Eliminates the need for tire technician to lift heavy commercial truck tires and wheels.
 - ▶ Great for everyday tire lifting and maneuvering.
 - ▶ Must have for any tire service center or service truck.
 - ▶ Avoid damaging of expensive tire/wheels.
 - ▶ No Need for assistance from second man to maneuver tire.
 - ▶ Easy to ship packaging makes it ideal for stock & ship.

Capacity	Net Weight	Works on Tire Sizes:	Width	Handle Length	Roller Length	Roller Distance from Ground
330 lbs. 150kg	28 lbs. 12.7kg	23.5" - 43.5"	27.5" 699mm	38" 965mm	9.625" 245mm	6" 152mm

Truck Wheel Dolly - For 19.5" through 24.5"

Model #70130

OSHA

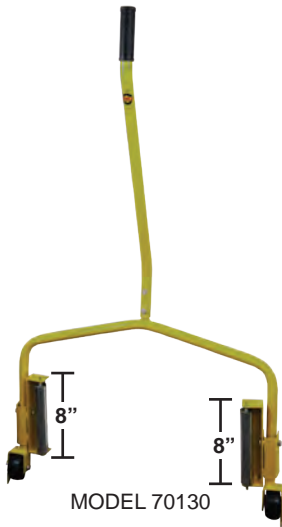

- ▶ Reduce back injuries in the shop.
- ▶ Tire/wheel is rotated left or right on tilt-able roller pads for perfect stud alignment.
- ▶ Perfect for 8-10 hole Budd type wheels.
- ▶ Removes tire/rim assembly fast and easy.
- ▶ Increases productivity.
- ▶ Saves time, money, and is maintenance free.
- ▶ Heavy duty tubular construction lifts 280 lbs. | 127 kg
- ▶ 3" caster/wheels roll the truck wheels for effortless removal or replacement.
- ▶ Works with tires 19.5" through 24.5"
- ▶ Use on standard size truck tire/wheel.
- ▶ Weight: 18 lbs. | 8 kg

SUPER Wheel Dolly - Designed for Super Singles

Model #70132

OSHA



- ▶ Heavy duty wheel dolly designed specifically for super single and flotation tires.
- ▶ 14" wide rollers accommodate even the largest super single wheels.
- ▶ Lifting capacity of 450 lbs. | 204 kg
- ▶ Weight: 26 lbs. | 12 kg



Portable Tire Step - Compact Folding Tire Step



60202: For Super Single Tire

60203: For Tire Sizes: 22.5"- 24.5"

- ▶ Heavy duty, portable safety step.
- ▶ Easy way to service truck engine compartments.
- ▶ Holds up to 400 lbs. | 181 kg
- ▶ Folds for compact storage (less than 4")
- ▶ Galvanized heavy duty steel construction.
- ▶ Weight: 19 | lbs. 8 kg



Chrome Wheel Protector - STANDARD Model

Model #50301



- ▶ Protects aluminum, chrome, and painted truck rims/wheels during stud and nut removal.
- ▶ Made of tough polymer material and outlasts regular plastic.

Chrome Wheel Protector - DELUXE Model

Model #50303



- ▶ Extra tough material that will last up to 2 years.
- ▶ Black in color and will last up to 20 times longer than standard rim guards.

E-Z Wheel Guards

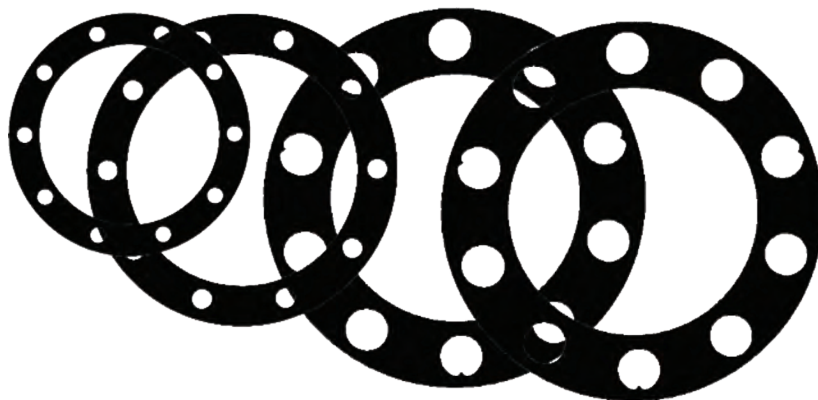

- ▶ Graphite/nylon separator plate is placed between the hub or drum and the wheel and/or between two wheels on a dual application.
- ▶ The wheel-guard is highly recommended in severe applications where corrosion and/or wear has been identified as a problem.
- ▶ Both aluminum and steel truck wheels will benefit from the wheel guard.

Model #	Hole Count	Bolt Circle	Stud Diameter	Studs For:
60100	10 Hole	11 1/4"	1 1/8" and 7/8"	Stud Piloted Wheels
60101	10 Hole	11 1/4"	3/4"	Stud Piloted Wheels
60102	10 Hole	285.75mm	22mm	Hub Piloted Wheels
60104	10 Hole	335mm	22mm	Hub Piloted Wheels
60105	8 Hole	275mm	20mm	Hub Piloted Wheels
60106	8 Hole	6 1/2"	4.82" ID, 5/8"	GM & Dodge
60107	8 Hole	6 1/2"	5.25 ID, 5/8"	Oval Holes, Ford
60108	8 Hole	225mm	6.75" ID, 5/8"	Locating Holes Ford 19.5"
60109	10 Hole	335mm/13.189"	22 mm	Budd Axle: Bus Wheels

Install Wheel Guards Here

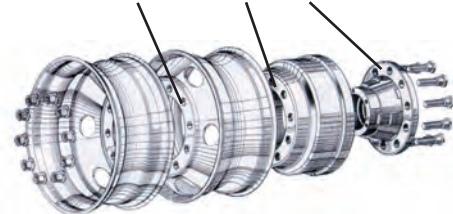

STOP electrolysis between aluminum wheels and steel hubs or between aluminum rims and steel rims.

STOP scale and corrosion between steel disc rims in dual or single wheel applications.

Budd Nut Wrench - DELUXE Model

Model #60300



MODEL 60300



- ▶ Removes frozen inner/ from outer cap nuts.
- ▶ Eliminates the need for hand and foot aid in separating the nuts, therefore reducing needless injury.
- ▶ Reduces the work and potential for back strain because there is no need to lay the tire down.
- ▶ Won't lose its grip on the outer cap nut so there is no loss of torque this will give the torque wrench maximum power and efficiency.
- ▶ Won't slip or rotate out of position, significantly reducing the potential for damage to chrome and aluminum wheels.
- ▶ Wrench Locks onto rim.
- ▶ Weight: 4 lbs. | 2 kg

Budd Nut Wrenches - Pork Chop Style



Model #	Sizes
60301	1 1/2" & 38mm
60302	35mm
60303	41mm



- ▶ Pork Chop Style-New design; can't slip out of rim hole
- ▶ Won't damage aluminum wheels.
- ▶ Holds outer cap nut securely.
- ▶ This new adaptation of an old product solves the problem of damage to wheels as well as broken toes and injuries to feet.
- ▶ All models have a replaceable polymer covered stopper that locks the tool securely in place.
- ▶ Weight: 1 lbs. | 0.5 kg

Wheel Nut / Chamfer Gauge

Model #60929



MODEL 60929



- ▶ Disc wheel measuring tool kit shows you when wheel and inner and outer cap nuts are worn out.
- ▶ Provides a guide to visually detect excessive wear in .875R spherical chamfers of bolt holes in disc wheels.
- ▶ Designed for use with stud piloted steel wheels which have .875 spherical bolt holes 3/8" to 1/2" disc thickness.
- ▶ Use only with Stud Piloted Steel Wheels.
- ▶ Weight: 1 lbs. | 0.5 kg

Slide Hammer Bead Breaker

Model #70150



MODEL 70150

OSHA



- ▶ Breaks the most stubborn beads with ease.
- ▶ Reduces user fatigue with its spring action design.
- ▶ This design prevents slide hammer kick back.
- ▶ The wedge foot is forced between the bead and rim flange, delivering blow directly to the tip.
- ▶ Heavy duty tool, will not break.
- ▶ Comparable to the Ken Tool T26B.
- ▶ Weight: 24 lbs. | 11 kg

Tuffbar - 24" Tire Bar w/ Rim Protecting Plates

Model #70208



MODEL 70208

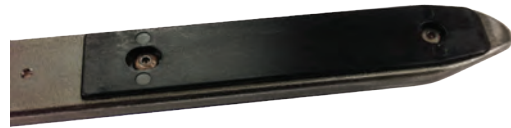

Backside Protection Plate for EXTRA Protection.



- ▶ Features Polymer Protection Plates to Protect Rim from Damage
- ▶ Greater Length for More Leverage
- ▶ Stronger than Standard Tire Bars
- ▶ Easy to Use
- ▶ 24" in Length | 610mm
- ▶ Weight: 3 lbs. | 1.4 kg

Mag Wheel Tool - Eliminates Damage to Mag, Chrome, & Alloy Wheels

Model #70200



MODEL 70200



- ▶ Eliminates "booties" that slip off "combo" tool - Change inserts in seconds.
- ▶ Not for use on steel wheels.
- ▶ Shipped complete with one set of replacement polymer inserts.
- ▶ Eliminates damage to mag, chrome, and alloy wheels.
- ▶ Fits all center post tire changers.
- ▶ Replaceable polymer inserts get 500 to 700 mounts/demounts when used correctly
- ▶ Weight: 6 lbs. | 3 kg

Mag Wheel Tool Replacement Parts



MODEL 70204



MODEL 70202



MODEL 70203

Model #	Style	Material
70201	Hook and Nose	Polymer
70202	Nose	Polymer
70203	Hook Body	Metal
70204	Hook Insert	Polymer

Mounting Clamp - For European Style Rims

Model #70210



MODEL 70210

- ▶ For European style rim clamp tire changers.
- ▶ Acts like a third and fourth hand.
- ▶ Clamp holds tire bead in drop center. Clamps quickly to rim, won't allow tire to "walk".
- ▶ Plastic, will not mar or scratch decorative or aluminum rims.

Manual Tire Spreader* - Turn-table Style (Spreader Only)

Model #90450



- ▶ Top post mounting passenger tire spreader
- ▶ Portable Tire Spreader

Tire Width	5.5"-10.875" 140mm-275mm	Overall Dimensions	20"25" L x 5.25" W x 10" H 515mm L x 134mm W x 254mm H
Tire Diameter Capacity	11" - 24"	Weight	13 lbs. 6 kg

Manual Tire Spreader - Turn-table Style (Spreader & Base)

Model #90455



MODEL 90455

- ▶ Top post mounting passenger tire spreader
- ▶ Portable Tire Spreader
- ▶ Tabletop Base Mount INCLUDED

Tire Width	5.5"-10.875" 140mm-275mm	Overall Dimensions	20"25" L x 5.25" W x 10" H 515mm L x 134mm W x 254mm H
Tire Diameter Capacity	11" - 24"	Weight	24 lbs. 11 kg

Manual Tire Spreader - with Tilting Pedal

Model #90451



MODEL 90451

- 1 Adjustable "Tilting" table - Makes service work faster & easier**
 - 2 Adjustable for larger range of tire sidewall size height/width**
 - 3 Tool Tray - to hold patches, tools, and more.**
- ▶ Portable Style Unit
 - ▶ 4-point adjustable table tilt - Easy pedal adjustment
 - ▶ Rotatable design allows for better positioning to work inside of wheel
 - ▶ Adaptable for a larger range of tire sidewall size heights/widths
 - ▶ Spreader arms adjustable to accommodate passenger & lightweight truck tires.

Tire Width	5.5"-10.875" 140mm-275mm	Overall Dimensions	24.75" L x 15" W x 35.5" H 629mm L x 381mm W x 902mm H
Tire Diameter	11" - 24"	Weight	65 lbs. 30 kg

Pneumatic Passenger & Light Truck Tire Spreader

Model #90453



MODEL 90453

- 1 Adjustable clamping arms for a wide range of tires**
 - 2 Tool Tray**
 - 3 Work Light - for better visual internal inspection**
 - 4 Operated by two foot pedals that control air actuated piston.**
- ▶ Designed for tire shops for the repair of passenger & light truck tires.
 - ▶ Aid in better visualization for proper inspection and/or internal repair.
 - ▶ Pressure gauge & regulator assembly

Tire Width	5.5"-10.875" 140mm-275mm	Overall Dimensions	24" L x 25.5" W x 36.5" H 610mm L x 648mm W x 927mm H
Tire Diameter	11" - 24"	Weight	135 lbs. 61 kg
Light Specs	110V	Air Pressure	110-145 PSI 8-10 Bar

OTR Tire Spreader - Air Hydraulic Tire Spreader & Lockout Safety Bar

NEW!

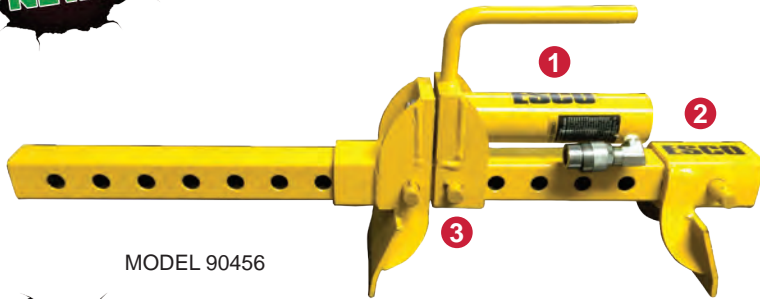

MODEL 90456

NEW!



MODEL 90456S

- 1 10 Ton Ram - 6" Stroke
- 2 Adjustable Extension Spade
- 3 Easy Locking Pin For Placement
- 4 Adjustable Extension Spade
- 5 Easy Locking Pin for Placement

- ▶ Tire Spreader, range 6" to 34"
- ▶ HEAVY DUTY 10 ton capacity
- ▶ Ideal for inspection & repairs on Truck/ Farm & OTR Tires
- ▶ 6" Stroke
- ▶ Safety lock every 2" interval
- ▶ Portable Design
- ▶ Can be used with both a Air Hydraulic Foot pump or Manual Hydraulic pump.
- ▶ Optional 34" Lockout Safety Bar, 90456S

The ESCO OTR Tire Spreader [MODEL #90456] is an uniquely designed heavy duty hydraulic spreader for use on off-the-road, mining, agricultural, and larger truck tires; where other spreaders may fail. Ideal for inspections and repairs, the ESCO OTR Tire Spreader is designed with simplicity and ease of use in mind and is a must have for any mobile service technician or service center. Also available is the OTR Safety Lockout Bar [MODEL #90456S] used in conjunction with the OTR Tire Spreader to assist in maintaining the separation between the tire, while releasing the hydraulic pressure from the spreader; making for a much "safer" environment for technician to work on tire.

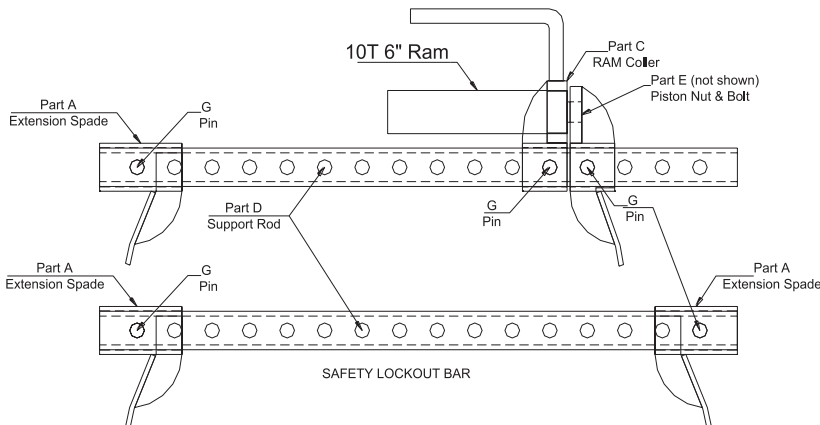

Main Breaker Bar Length	34" 864mm
Optional Safety Bar Length	34" 864mm
Ram Travel	6" 152mm
Weight	
90456	36 lbs. 16kg
90456S	18 lbs. 8kg

Balancing Beads - Lead the Way in New Balancing Technology with ESCO Balancing Beads!



ESCO Balancing Beads consist of thousands of uniquely designed beads that will automatically adjust to the imbalance of the tire based on the principle of centrifugal force. The ESCO Balancing Beads naturally find the unbalanced side of the tire and gathers together to create a counter-weight that balances the tire regardless of changes in the tire weight due to normal conditions.

When lead, steel, and other material wheel weights are applied to the rim, they're placed in the position that is opposite of the imbalanced side of the tire. With ESCO Balancing Beads, this process is done internally just the same as wheel weights. The big difference is ESCO Balancing Beads balance the tire for the life of the tire and adapt as the outside rubber of the tire wears down with time.

BENEFITS:

- *Improve Fuel Economy*
- *Increase Tire Life*
- *Reduce Vibration*
- *Reduce Maintenance Costs*
- *Easy to Install and Maintain*
- *Environmentally Friendly*

- ▶ Thousands of uniquely designed Beads that shape to the tire.
- ▶ Balances the tire internally.
- ▶ Disperses evenly throughout the Wheel creating a consistent balance.
- ▶ EASY installation.
- ▶ Single bag per wheel.
- ▶ Beads are static free and roll freely to keep tires balanced as the tire naturally matures.
- ▶ ESCO Tire Balancing Beads are reusable and are **Eco-Friendly**.
- ▶ Can be used in both Automotive and Truck Tires.

Model #	Type of Tire	OZ. Per Bag
20467C	Automotive Tire	2 oz. bag
20468C	Automotive Tire	3 oz. bag
20469C	Automotive Tire	4 oz. bag
20470C	Automotive Tire	6 oz. bag
20462C	Truck Tire	8 oz. bag
20463C	Truck Tire	10 oz. bag
20464C	Truck Tire	13 oz. bag
20465C	Truck Tire	16 oz. bag
20466C	Truck Tire (Bulk Qty.)	17.6 lbs. (282 oz.)

Sold 24 Bags Per Case



EASY TO USE **ECO FRIENDLY**



SEE REFERENCE PAGE 92 FOR APPLICATION CHART OR SCAN QR CODE

Liquid Truck Tire Balancer - Balance, Lubricate, & Extend Tire Life

Model #20471

Free Flowing Liquid Tire Balancer and Lubricant!



32 oz. Bottle
MODEL 20471

Sold Per Case
(12 per case)

- ▶ Fluid Dynamic Tire Balancing Method.
- ▶ Eliminates Need for Weights.
- ▶ Keeps Bead Area Flexible.
- ▶ Contains Contact & Vapor Rust Inhibitors.
- ▶ Helps Maintain Air Pressure.
- ▶ Will Not Block Valve Stem.
- ▶ Extends Tire Life.
- ▶ Does Not Freeze.
- ▶ Eco-Friendly Material.
- ▶ Versatile way to Balance Truck Tires.
- ▶ Adjusts to each driving condition as it changes, keeping Truck Tires at the Peak of Performance.
- ▶ Freeze protected up to - 40 °F.
- ▶ Extends life of Tires, Eliminates Rust, and Makes Mounting and Demounting Easier.

*EXCEPTIONS LIST:

REMINDER:

All Application & Sizes are based on recommendation. For extreme situations please contact an ESCO representative.

19.5" Tires	16 oz.
235-85R16 Tires	8 oz.
385 Floats	48 oz.
425 Floats	64 oz.
445 Floats	64 oz.

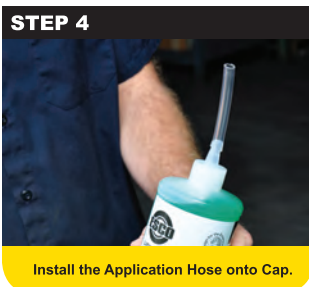
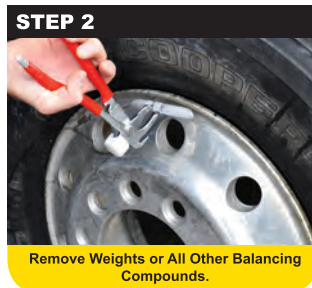

Recognized for Safer Chemistry
www.epa.gov/dfe

22.5 & Above Use 32 oz.*
EASY INSTALLATION & APPLICATION!

Liquid Transfer Pump - Complete with Hoses, Injector Gun, & Valve

Model #10543



MODEL 10543

Popular for
Transferring
Calcium Chloride

Fast & Easy Fluid Transfer from One Container to Another.

Multiple Fluid Applications: Most Commonly used for Calcium Chloride Transferring.

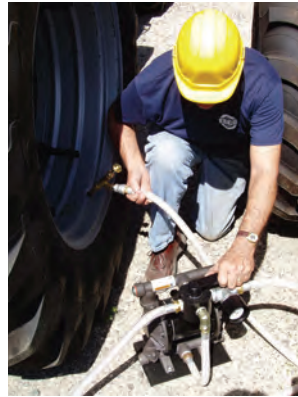

- ▶ Unit is portable or can be mounted in tire service trucks.
- ▶ Gauges are protected.
- ▶ Pump 1 to 1 ratio
- ▶ Spring reinforced hoses for fill and evacuate.
- ▶ Comes Complete with
- ▶ Complete with (2) 10ft. Hoses; 10522 Injector Gun, & 10515 4-way Metal Valve.
- ▶ Weight: 44lbs.. | 20 kg

Liquid Transfer Pump Injector Gun

Model #10522



MODEL 10522

- ▶ Valve Adapter Gun has a 1/2" female pipe thread and will attach to any calcium tire filling pump
- ▶ It will Extract the valve core from standard and large bore valves or the core housing from a tractor valve
- ▶ It will securely hold the valve core or core housing in the gun body during tire filling or evacuation of liquid from a tire

Liquid Transfer Pump 4 Way Metal Valve

Model #10515



MODEL 10515

- ▶ Replacement Metal Valve
- ▶ Anodized aluminum valve outlasts brass valves 10:1
- ▶ Works great on ESCO liquid Transfer Pumps
- ▶ 1" valve ports ideal for high flow pump output & 3/4" Port

50 GPM Liquid Transfer Pump

Model #10540P



MODEL 10540P

- ▶ 50 GPM
- ▶ 1" hose intake.
- ▶ Pump assembly less additional valve and hose hardware as well as base plate and regulator/gauge assembly.
- ▶ Weight: 22 lbs. | 10 kg

WHEEL+AID - Rim Rust Eliminator & Lubricant

ENVIRONMENTALLY FRIENDLY PRODUCT

WHEEL+AID Rim Rust Eliminator & Lubricant



MODEL 10925
6 GALLON BUCKET



MODEL 10926
55 GALLON DRUM



MODEL 10927
275 GALLON TOTE

WHEEL+AID Rust Eliminator & Lubricant is a specially formulated, Non-fiber, light viscosity fluid that offers exceptional tire and rim protection when added to the tire air chamber.

Why Choose WHEEL+AID to Protect Your Wheels?

- ▶ Lubricates for quick tire removal and perfect bead seat when mounting tires.
- ▶ Eliminates rust inside the wheel, o-ring, and bead area.
- ▶ Tires run cooler, extending tire tread life.
- ▶ Helps prevent rim and vent leaks.
- ▶ Increases casing retreadability by helping to control oxidation and brittleness.
- ▶ Helps maintain air pressure by keeping the bead area conditioned and pliable.
- ▶ Tire Changer Friend - Makes the job easier.
- ▶ Retread shop friendly - 100% NON-FLAMMABLE
- ▶ Will NOT Block valve Stem or Freeze in Tire/Rim.
- ▶ Recognized by the Environmental Protection Agency [EPA] in the United States.

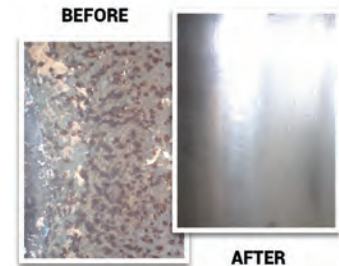

Point.Scan.Explore.



RECOMMENDED APPLICATION AMOUNT BY TIRE:

2 Gallons [8 Liters]	3 Gallons [11 Liters]	4 Gallons [15 Liters]	5 Gallons [19 Liters]	6 Gallons [23 Liters]	8 Gallons [30 Liters]	15 Gallons [57 Liters]
12.00-24	18.00-25	18.00-33	24.00-35	24.00-49	45/65-45	37.00-57
13.00-24	21.00-25	21.00-35	33.5-33	37.5-33	27.00-49	
14.00-24	20.5-25	26.5-29	29.5-35	37.25-35	30.00-51	20 Gallons [76 Liters]
16.00-25	23.5-25	29.5-29	33.25-35	35/65-33		40.00-57
15.5-25	26.5-25	33.25-29		37.5-39	10 Gallons [38 Liters]	50/80-57
17.5-25	29.5-25	24.5-32			33.00-51	
14.9-24	16.9-28				36.00-51	
16.9-24	18.4-28				50/65-51	25 Gallons [95 Liters]
17.5L-24	21L-24					ALL 63"
19.5L-24						

Air Bag Jacks - Molded Inflatable Jacks

OSHA



- ▶ **MAXIMUM** Force Air Bags.
- ▶ **THIN** reinforced, molded inflatable jacks.
- ▶ **CAN** be positioned in tight or confined spaces with as little as one inch clearance.
- ▶ Lifting capabilities range from 10 Tons to over 70 Tons.
- ▶ **MADE** of aramid fiber consisting of five layers
- ▶ ESCO Airbags also come in Kit form which includes the Air Bag (See details below)
- ▶ Air bags may be used for lifting in several different industries such as:

Material Handling • Railroad Work
Mining • Rescue • Military •
Agricultural • OTR Tire Changing

AIRBAG KIT



Kit Includes Air Bag and the Following:	Model #
Single Safety Relief and Control Valve	12119
Nipple and Industrial Nipple with Valve	12123
20 Feet Air Bag Jack Hose and Couplers	12122

Air Bag Only:	Weight	Lift Capacity	Dimensions	Height Max Inflation	Air Bag Jack Kits	Weight
12105	10 lbs. 4.5 kg	13 Tons	15" x 15" x 1" 381mm x 381mm x 25mm	7.5" 191mm	12105K	18 lbs. 8 kg
12107	17 lbs. 8 kg	22 Tons	20" x 20" x 1" 508mm x 508mm x 25mm	9.5" 241mm	12107K	28 lbs. 13 kg
12109	24 lbs. 11 kg	32 Tons	21" x 25" x 1" 534mm x 635mm x 25mm	12" 305mm	12109K	32 lbs. 15 kg
12112	45 lbs. 20 kg	50 Tons	29" x 29" x 1" 737mm x 737mm x 25mm	15" 381mm	12112K	49 lbs. 22 kg
12113	52 lbs. 23 kg	70 Tons	34" x 34" x 1" 864mm x 864mm x 25mm	18" 457mm	12113K	70 lbs. 32 kg

Steel Cribbing Stands - 3", 6", & 9" Stackers

OSHA



All pieces interlock and can be used individually or stacked together for various lift heights. They will not slide or shift during lifting.

MAXIMUM CAPACITY 55 TONS

MAKES LIFTING EASIER & FASTER

Model #	Tonnage	Size	Wgt.
12500	55	3"/6"/9"	141 lbs.
	50 Tonne	76mm/152mm/229mm	64 kg
12501	55	3"	38 lbs.
	50 Tonne	76mm	17 kg
12502	55	6"	47 lbs.
	50 Tonne	152mm	21 kg
12503	55	9"	56 lbs.
	50 Tonne	229mm	25 kg



OTR Tire Sling - Heavy Duty Design for the Heaviest Duty Application

Model #90100

OSHA



MODEL 90100



- ▶ Fast and easy way to handle tires in the horizontal or vertical position.
- ▶ Endless chain and locking device allows operator to position the tire as desired.
- ▶ Tire can be locked in any position.
- ▶ For tires sizes up to 39"
- ▶ 6,500 lbs. capacity per chain at 60 degrees.
- ▶ Weight: 56 lbs. | 25 kg

2 Way Pushing Bar - 51" Pushing Bar

Model #90200

OSHA



MODEL 90200



- ▶ Works from the end of the truck boom and is used to depress or push back the bead seat band and flange ring for fast and easy removal of locking ring on OTR/Earthmover 5 piece rims OTR/Earthmover tires.
- ▶ Standard unit fits 25" through 51" rims.
- ▶ Fits all Boom Truck Cranes (Some May Need Slight Modification)
- ▶ Meets OSHA requirement and acts as a tire inflation cage when left in position during the inflation of Earthmover tires.
- ▶ Weight: 65 lbs. | 29.5 kg

Flange Rim Puller

Model #90300



MODEL 90300

- ▶ Designed to lift the rim base from the tire, remove the bead seat band from the tire, or aid in the seating of the bead seat band during inflation.
- ▶ Features 4-point chain hook assembly.
- ▶ Easily attaches to the boom.
- ▶ 21,600 lbs. capacity.
- ▶ 5,400 lbs. capacity per chain.
- ▶ Weight: 34 lbs. | 15 kg

Bead Hooks



MODEL 90400



MODEL 90401



MODEL 90402

- ▶ Fits all truck mounted tire cranes.
- ▶ Heavy duty, rugged construction.
- ▶ Contour of hook same as tire bead.
- ▶ Angle of tool won't allow tire to slip off when lifting.
- ▶ Prevents bead damage.

Model #	Rated For	Capacity	Weight	Height	Width
90400	Light Duty	5,500 lbs.	33 lbs. 15 kg	17.5" 445mm	8.25" 210mm
90402	Medium Duty	12,000 lbs.	39 lbs. 18 kg	19" 483mm	11" 280mm
90401	Heavy Duty	16,000 lbs.	59 lbs. 27 kg	24" 610mm	14.5" 368mm

OTR Large Tire O-Ring Installer - Lightweight Aluminum Construction

Model #40807

NEW!



MODEL 40807

- ▶ Used on 25" to 36" OTR Tires
- ▶ Designed and built to manually install and remove O-Rings
- ▶ Unit is also used to separate the inside and outside beads
- ▶ Assists in the removal and installation of the lock ring



Tire Diameter	Width	Length	Height	Weight
25"-36" 635-914mm	3" 76mm	32.5" 825mm	14.5" 368mm	36 lbs. 16 kg

RingMaster - O-Ring/Lock Ring Installer

**RING
MASTER**

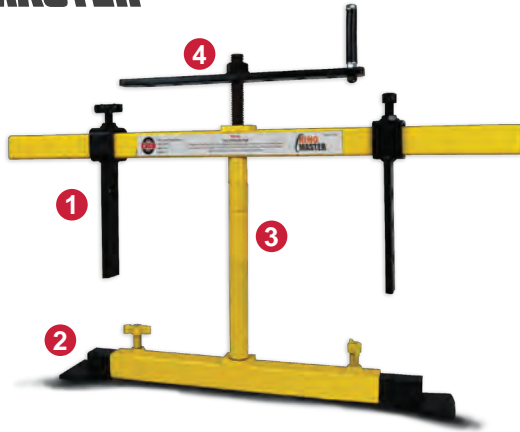

MODEL 70162

- 1 Adjustable Arms Push Against Rim
- 2 Adjustable Feet - To Fit Width of the Rim
- 3 Stacker Pieces - To adjust Area of Extension
- 4 Easy Action Rotating Arm - For Lock Ring Removal

- ▶ Lightweight and Easy to Use
- ▶ Pushes & Holds Rim Flange/Tire Back for Easy O-Ring/Lock Ring Installation
- ▶ Portable- Fits in Tire Truck Tool Box. Eliminates use of Boom Crane & Cumbersome Tire Tools
- ▶ Easy One Man Operation
- ▶ Works on all 3 Piece & 5 Piece Rim/Wheels up to 39" in Diameter (See Model Specs Below)
- ▶ Eliminates Danger of Pushing Equipment Off Jack with Crane.



Point.Scan.Explore.

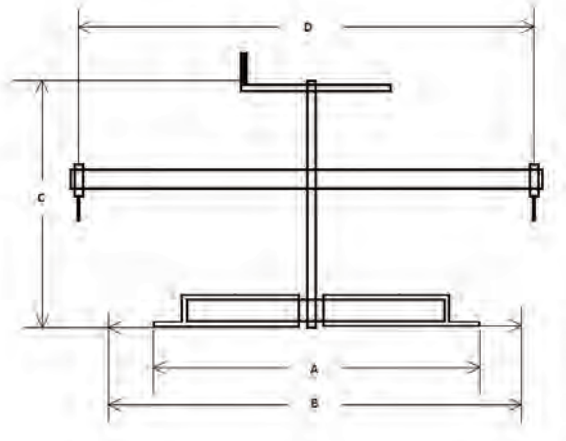

	A	B	C	D	Weight
MODEL #70162	22.25 in 565 mm	32 in 813 mm	18 in 457 mm	28 in 711 mm	22 lbs. 10 kg

RingMaster - For Extended Planetary Flange Wheels



MODEL 70162K
(INCLUDES MODEL 70163)



MODEL 70163
For 24" Through 29"



O-Rings

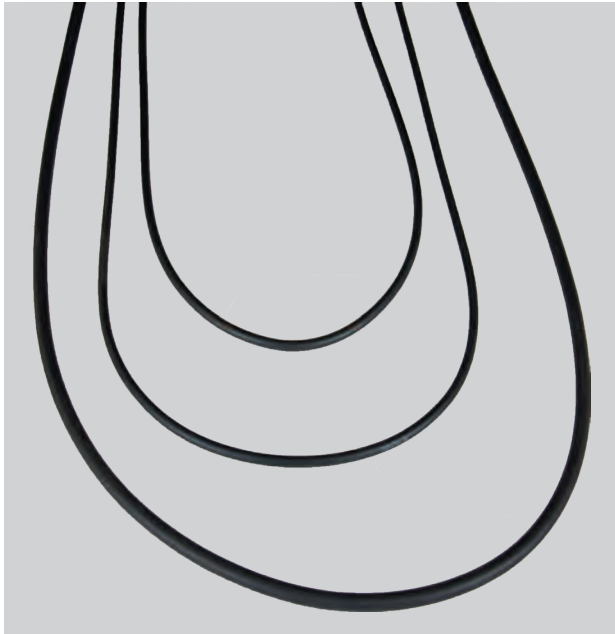

- ▶ Sold in Case Lots
- ▶ Packaged in a poly bag (2 per bag)
- ▶ High Quality Product
- ▶ Made in the USA
- ▶ Individually marked O-Rings make it easier to read
- ▶ Manufactured of the highest quality material
- ▶ Manufactured to OEM Specifications
- ▶ Working environment -40°F to 180°F



ESCO Model	Tire Type	Rim Size	Rod Diameter	Qty/Case
ESC-OR-220TG-CASE	Grader	20"	0.260"	24
ESC-OR-224TG-CASE	Grader	24"	0.260"	24
ESC-OR-225T-CASE	Grader	25"	0.260"	24
ESC-OR-24JM-CASE	Highway (JM Rim)	24"	0.260"	24
ESC-OR-25T-CASE	Earthmover	25"	0.260"	24
ESC-OR-325T-CASE	Earthmover	25"	0.375"	24
ESC-OR-329T-CASE	Earthmover	29"	0.375"	24
ESC-OR-333T-CASE	Earthmover	33"	0.375"	24
ESC-OR-335T-CASE	Earthmover	35"	0.375"	24
ESC-OR-339T-CASE	Earthmover	39"	0.375"	24
ESC-OR-345T-CASE	Earthmover	45"	0.375"	24
ESC-OR-349T-CASE	Earthmover	49"	0.375"	24
ESC-OR-451T-CASE	Earthmover	51"	0.500"	12*
ESC-OR-457T-CASE	Earthmover	57"	0.500"	12*
ESC-OR-20JM-CASE	Highway (JM Rim)	20"	0.260"	24
ESC-OR-215T-CASE	Grader	15"	0.260"	24
ESC-OR-217L-CASE	Grader	17"	0.260"	24
ESC-OR-21T-CASE	Highway	21"	0.260"	24
ESC-OR-22JM-CASE	Highway (JM Rim)	22"	0.260"	24
ESC-OR-321T-CASE	Earthmover	21"	0.375"	24
ESC-OR-343T-CASE	Earthmover	43"	0.375"	24
ESC-OR-449T-CASE	Earthmover	49"	0.500"	12*
ESC-OR-463T-CASE	Earthmover	63"	0.500"	12*

*Packaged one-piece per poly bag

For More Information About O-Rings Contact An ESCO Representative

Agricultural & Earthmover Wheel Dolly

Model #90538



MODEL 90538

- 1 Adjustable for Height of Tire
- 2 Action Pedal to Lower & Raise Positions
- 3 Easy Rollers to Position Wheel/Tire
- 4 Adjustable Arm for Width of Tire

- ▶ Easy and Safe mounting, demounting and handling of large wheels on agricultural and earthmoving machinery.
- ▶ Capable of Handling Large Wheels from 49" | 1250mm up to 94.5" | 2400mm in diameter and up to 41.3" | 1050mm in depth, with a lifting capacity of 3,528 lbs. | 1600 kg
- ▶ Weight: 350 lbs. | 158 kg

Point.Scan.Explore.



NEWLY REDESIGNED
To Handle a Wider Range of
Tire/Wheel Combinations!!



Double Acting Hydraulic System, allowing for hands-free switch between lifting and lowering action for safe and controlled lowering.



2" x 4" large rollers improve handling of tires with deep treads.



Mobile: Easy to use outside the workshop. Disassembled in a few seconds.

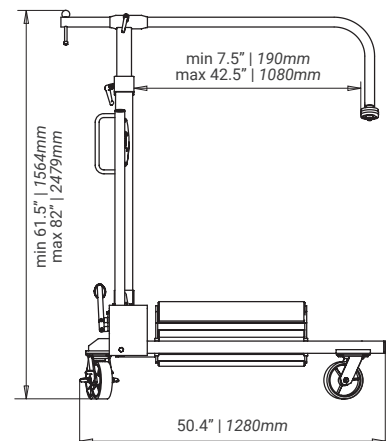
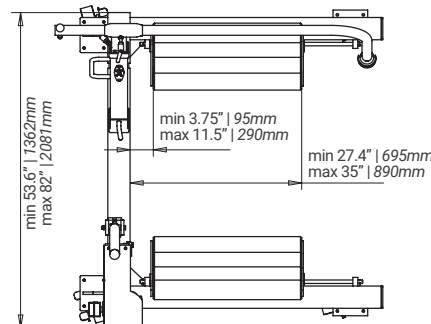

2 Ton Air Bladder Jacks - 2 & 3 Bag Style(s)



- ▶ Easy Operation - Up & Down Function Simple to Use.
- ▶ Designed for constant use in professional and hobbyist environments.
- ▶ Small compact design - Great for Shops, Hobbyist, or service vehicles.
- ▶ Popular choice for collision repair shops for use with frame machines.
- ▶ Ideal for use in brake, suspension, tire/wheel and many other applications.
- ▶ 100% Air up and Air Down.
- ▶ Built in Stabilization Cylinder.
- ▶ Low Profile Bladder Jack - Minimum Height of 4.5 in. (92040)



Model # Description	92040 2-Stage	92041 3-Stage
Capacity	2 Ton (4,000 lbs.)	2 Ton (4,000 lbs.)
Working Air Pressure	100-145 PSI	100-145 PSI
A (Min. Height)	4.5 in. 115mm	7.9 in. 200mm
A+B+C (Max. Height)	17 in. 430mm	22 in. 560mm
B (Lifting Height)	9.25 in. 235mm	11.8 in. 300mm
C (Extension Height)	3 in. 80mm*	2.25 in. 60mm**
D (Width)	10.4 in. 265mm	9.8 in. 250mm

* Included with 92040
** Included with 92041

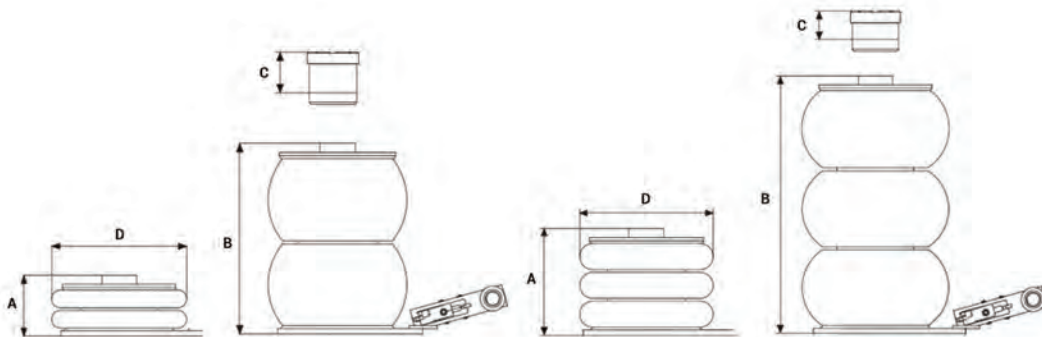

Bladder Jacks - Portable, Compact Air Operated Jacks



MODEL 92011



MODE 92013

- ▶ Pneumatically controlled jacks consisting of a highly resistant diaphragm and internal telescopic guide.
- ▶ These are fitted with a limit stop device as well as a safety valve making them absolutely reliable in the case of excessive loads.
- ▶ Silent, simple and lightweight, they are ideal for tire technicians and bodywork shops in view of the fact they can also be used on column lifts.
- ▶ Also available in the trolley version (See Below Specs)



MODEL 92012



MODEL 92014



SPECIFICATIONS:	Model Style	92011 YAK 132	92012 YAK 132/C	92013 YAK 203	92014 YAK 203/C
	Capacity	2.2 Ton 2 Tonne	2.2 Ton 2 Tonne	2.2 Ton 2 Tonne	2.2 Ton 2 Tonne
	Net Weight	31 lb 14 kg	35 lb 16 kg	37 lb 17 kg	42 lb 19 kg
	Working Air Pressure	116-145 psi 8-10 bar	116-145 psi 8-10 bar	116-145 psi 8-10 bar	116-145 psi 8-10 bar
	A	NA	42.13" 1070 mm	NA	42.13" 1070 mm
	B	16.34" 415 mm	14.37" 365 mm	16.34" 415 mm	14.37" 365 mm
	C	9.84" 250 mm	9.84" 250 mm	9.84" 250 mm	9.84" 250 mm
	D	5.2-12.83" 132-326 mm	5.2-12.83" 132-326 mm	8.07-19.29 in 205-490 mm	8.07-19.3" 205-490 mm
	E	2.2 Ton 2 Tonne	2.2 Ton 2 Tonne	2.2 Ton 2 Tonne	2.2 Ton 2 Tonne

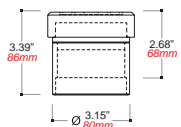

Model 91017

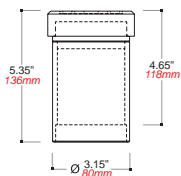

Model 92018

Bladder Jack 2 Ton
Extensions Not Included.

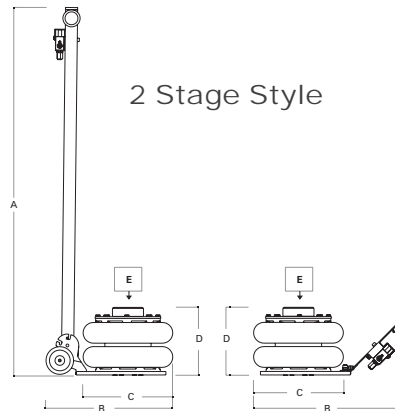

2 Stage Style

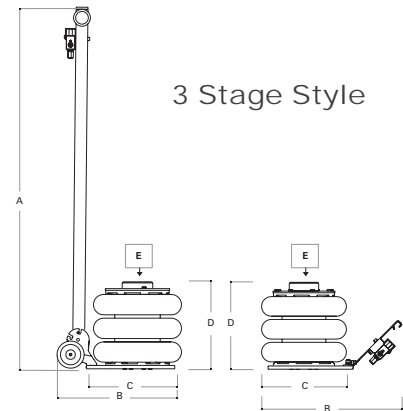

3 Stage Style

2 Ton Jack - Low Height Floor Jack w/ Foot Pedal

Model #90530



MODEL 90530



- ▶ Ergonomically designed handle for operator comfort. Rubber Coated.
- ▶ Easy "Lift-and-Turn" lowering system prevents unintentional lowering.
- ▶ Additional foot pedal pumping feature provides fast saddle raising to the load.
- ▶ Safety lowering control valve for safe lowering even under maximum load.
- ▶ Accessories available for this an other Compac Units. (See Accessories section for more details.)

Max (Ton)	2 TON	C	28.74" 730 mm
Weight	82 lbs. 37 kg.	D	6.3" 160 mm
A	3.15" 80 mm	E	14.96" 380 mm
B	19.69" 500 mm	F	36.42" 925 mm

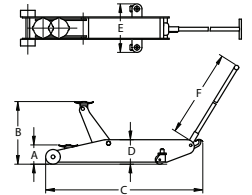

3 Ton Jack - Low Height Jack for Vans, 4WD, & Minibuses

Model #90531



MODEL 90531



- ▶ Ergonomically designed handle for operator comfort. Rubber Coated.
- ▶ Easy "Lift-and-Turn" lowering system prevents unintentional lowering.
- ▶ Additional foot pedal pumping feature provides fast saddle raising to the load.
- ▶ Safety lowering control valve for safe lowering even under maximum load.
- ▶ Accessories available for this an other Compac Units. (See Accessories section for more details.)

Max (Ton)	3 TON	C	39.96" 1015 mm
Weight	93 lbs. 42 kg.	D	6.69" 170 mm
A	4.53" 115 mm	E	14.96" 380 mm
B	19.69" 500 mm	F	36.42" 925 mm

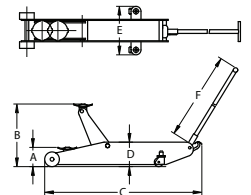

2 Ton Jack - High Lift Jack w/ Foot Pedal

Model #90534



MODEL 90534



- ▶ Ergonomically designed handle for operator comfort. Rubber Coated.
- ▶ Easy "Lift-and-Turn" lowering system prevents unintentional lowering.
- ▶ Additional foot pedal pumping feature provides fast saddle raising to the load.
- ▶ Long reach chassis improves access to lifting points deep under vehicle.
- ▶ Safety lowering control valve for safe lowering even under maximum load. Pressure relief valve prevents overloading.

Max (Ton)	2 TON	C	40.75" 1035 mm
Weight	117 lbs. 53 kg.	D	6.3" 160 mm
A	3.86" 98 mm	E	15" 380 mm
B	28.94" 735 mm	F	41.14" 1045 mm

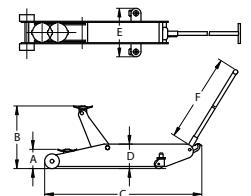

1.5 Ton Jack - High Lift Jack w/ Foot Pedal

Model #90535



MODEL 90535

- ▶ Ergonomically designed handle for operator comfort. Rubber Coated.
- ▶ Easy "Lift-and-Turn" lowering system prevents unintentional lowering.
- ▶ Additional foot pedal pumping feature provides fast saddle raising to the load.
- ▶ Long reach chassis improves access to lifting points deep under vehicle.
- ▶ Safety lowering control valve for safe lowering even under maximum load. Pressure relief valve prevents overloading.

Max (Ton)	1.5 TON	C	41.34" 1050 mm
Weight	117 lbs. 52 kg.	D	6.3" 160 mm
A	3.86" 98 mm	E	15" 380 mm
B	31.5" 800 mm	F	36.42" 925 mm

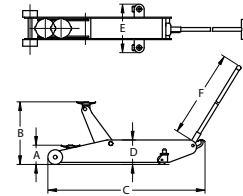

2 Ton Jack - Low Profile Jack

Model #90555



MODEL 90555

- ▶ Ultra low entry height.
- ▶ Extremely low chassis
- ▶ Additional foot pedal pumping feature provides fast saddle raising to the load.
- ▶ Ergonomically designed handle for operator comfort. Rubber Coated.
- ▶ Easy "Lift-and-Turn" lowering system prevents unintentional lowering.
- ▶ Accessories available for this and other Compac Units. (See Accessories section for more details.)

Max (Ton)	2 TON	C	37.4" 950 mm
Weight	91 lbs. 41 kg.	D	5" 126 mm
A	3" 77 mm	E	15" 380 mm
B	19" 480 mm	F	36.4" 925 mm

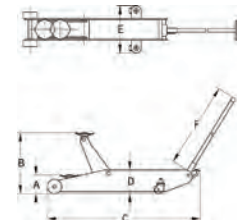

Point.Scan.Explore.



Jack Accessory - Rubber Saddle Protection Pad

Model #90572



- ▶ Rubber pad protects the shape and the coating of the lifting point.
- ▶ Lifting pad good for ESCO Model #: 90541, 90530, 90535, 90534, 90532, 90533, 90531

Jack Accessory - Extra Height Saddle

Model #90573



- ▶ 1.6" | 40mm Saddle for extra height or accessing lifting points situation behind skirts, etc.
- ▶ Lifting pad good for ESCO Model #: 90541, 90530, 90531

2 & 3 Ton Floor Jack - Pro Series Trolley Style Service Jack

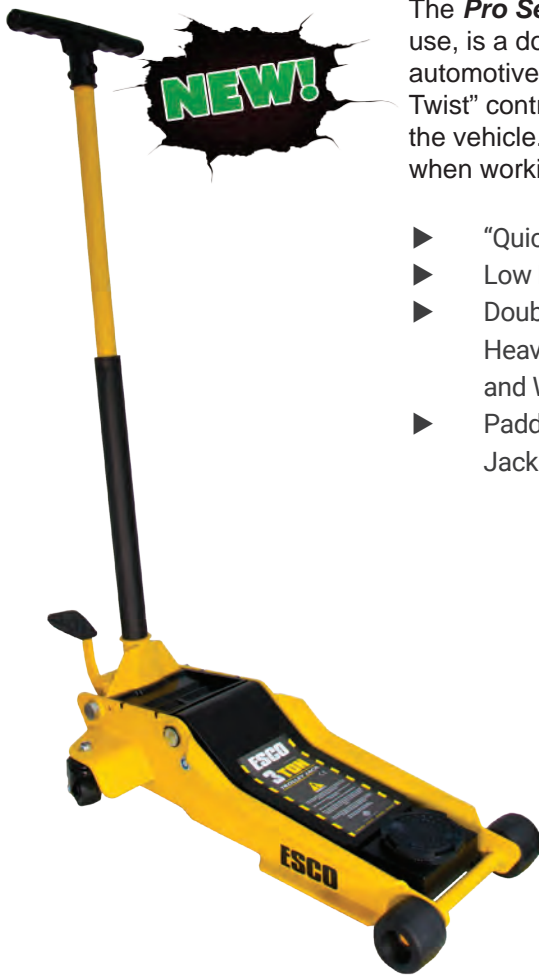

The **Pro Series** 2 & 3 Ton Trolley Jack designed for Professional and DIY use, is a double pump, professional lifting jack designed for the lifting of automotive and medium sizes trucks and vans. Features unique "Lift & Twist" controlled lowering of jack and foot pedal for much faster raising up the vehicle. Jack also include build in "Tools & Parts Tray" for convenience when working on vehicle.

- ▶ "Quick Lift" Pedal Raises Jack Quickly Without Pumping.
- ▶ Low Profile – 2.95" | 75 mm Minimum Height (Model #90520)
- ▶ Double Pump – Lowers Load Safely With Precision And Control.
- ▶ Heavy Duty Nylon Wheels – Designed To Withstand Constant Use and Will NOT Damage Shop Floors.
- ▶ Padded Handle For Protecting Vehicle Finish From Damage While Jack In Use.

Uniquely designed "Lift & Twist" controlled lowering function. Allows for **EASY** and **CONTROLLED** Lowering of Vehicle.

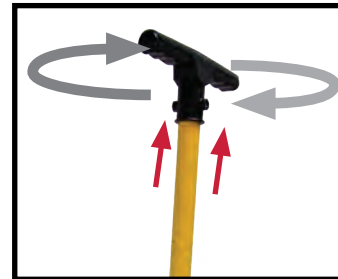

DOUBLE PUMP - Fast Rising of Jack with Double-Pump Technology. Use Foot Pedal to reach Load Quickly.



"Quick Lift" Pedal raises that jack quickly to the load without pumping.

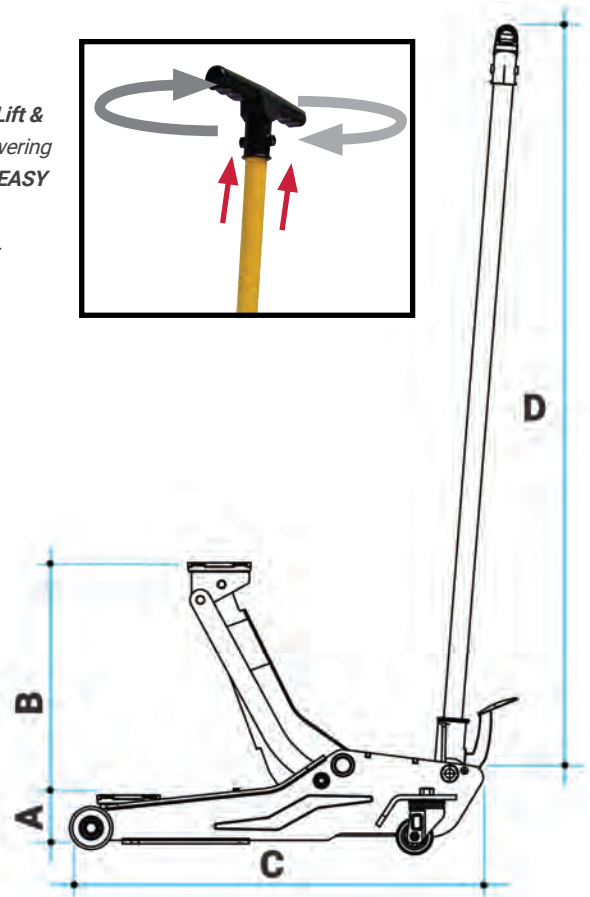

Model Style	CAPACITY Tonnage	MIN HGT. (A)	MAX. HGT. (B)	JACK LENGTH (C)	HANDLE (D)	WEIGHT
90520	2 TON	2.95" 75mm	19.69" 500mm	28.35" 720mm	47.25" 1200mm	80 lbs. 36 kg
90521	3 TON	3.75" 95mm	19.69" 500mm	28.35" 720mm	47.25" 1200mm	90 lbs. 40.5 kg

miniLIFT Classic - Compact Mobile Lifting System

Model #92050



MODEL 92050

The "Classic" miniLIFT is designed specifically for compact and versatile lifting in a wide range of vehicle service locations. Built to the highest quality, the ESCO miniLIFT is a must have for any bodyshop, garage, tire-shops, and more.

- 1 Valve with protection, conforming to CE Standards.
- 2 Top quality air-spring for the highest security built by "Continental".
- 3 Large lifting pad with 18.9" (48 cm) length.
- 4 Additional pad for side lifting.
- 5 Big direction wheels to roll even on grills and other surfaces.



- ▶ The original system for compact and fast lifting for the automotive market.
- ▶ The miniLIFT "Classic" enables you to work at the right height for: Bodyshops, Garages and Tire-shops.
- ▶ Small design, you can easily place the lift under the required vehicle and work properly as with any other lift.
- ▶ Extremely versatile lift, which allows you to lift any small/large car, vans and SUVs on the market
- ▶ "Classic" miniLIFT includes Set of 2 Ton Jack Stands (Model 92053) and Side Lifting Pad.



Point.Scan.Explore.

Lifting Capacity	Length	Width	Min. Height	Lift Capacity	Max. Vehicle Weight	Working Hgt. (Back)	Working Hgt. (Front)	Min. Air Supply	Weight
2.2 Ton	54 in. 1372mm	23.5 in. 889mm	5.25 in. 133mm	5510 lbs. 2500 kg	7055 lbs. 3200 kg	61 in. 1549mm	43 in. 1092mm	90 psi 104 kg	245 lbs. 111 kg

Side Lifting Pad (Included)



2 Ton Support Stands (Included)



MODEL 92053

SUV Conversion Set (Sold Separately)



MODEL 92051

Rubber Lifting Pads (Sold Separately)



MODEL 92052

miniLIFT Lift n' Move - Compact Mobile Lifting System

Model #92055



MODEL 92055

The miniLIFT "Lift & Move" is a superb fast compact lifting system, which enables you to work on the vehicle at the right height and also, easily move the vehicle to the next required area by quickly attaching trolley wheels to the lift.

- 1** Lift and Move System - Allows for vehicle lifting and maneuverability in shop.
- 2** Quality Caster Wheels that roll well on shop floors.
- 3** Adjustable Lifting Pads (5-8 in. of Height)
- 4** Easy to attach Lift & Move System with Safety Pins.
- 5** Control Panel includes air up and down function as well as "Bag Raise" function for Quicker Raising of Jack onto Lift & Move Wheels



- ▶ Work at the right height for: Bodyshops, Garages and Tire-shops
- ▶ With its small design, you can easily place the lift under the required vehicle and work properly as with any other lift
- ▶ Extremely versatile lift, which allows you to lift any small/large car, vans and SUVs on the market
- ▶ Comes with a pair (2) of trolley wheels (Model #92058) and a pair (2) of 2 Ton jack stands (Model #92053)



Point.Scan.Explore.

Lifting Capacity	Min. Length	Max. Length	Width	Min. Height	Adjusted Height Max.	Lift Capacity	Maximum Hgt.	Min. Air Supply	Weight
2.5 Ton	46.5 in. 1181mm	63 in. 1600mm	25.4 in. 645mm	5 in. 127mm	8 in. 203mm	5000 lbs. 2500 kg	25.5 in. 648mm	90 psi 104 kg	340 lbs. 157 kg

Trolley Wheels (Included)



MODEL 92058

2 Ton Support Stands (Included)



MODEL 92053

SUV Conversion Set (Sold Separately)



MODEL 92056

Rubber Lifting Pads (Sold Separately)



MODEL 92057

2.2 Ton Transmission Jack - Truck Style

Model #10812



MODEL 10812

- ▶ Safety overload system.
- ▶ Wide chassis design provides maximum stability.
- ▶ Fully adjustable universal saddle, brackets and chain sling.
- ▶ Four swivel casters help move jack easily.
- ▶ 360 degree rotatable pump handle for operation in any position.
- ▶ Easy access to relief valve to lower the jack.
- ▶ Sealed hydraulic unit prevents contamination.

Lifting Capacity	Min. Height	Max. Height	Weight
2.2 Ton	10" 254mm	35" 889mm	230 lbs. 104 kg

4 Ton Forklift/Tractor Jack - 4Ton Lifting Capacity

Model #10435



MODEL 10435



- ▶ Perfect for shop or service vans
- ▶ Lightweight and compact
- ▶ Meets ANSI/CE standards
- ▶ Removable handle

FORKLIFT SUPPORT STANDS AVAILABLE:
Refer to Page 88

Lifting Capacity	Min. Height	Max. Height	Weight
4 Tons 8,800 lbs.	2.25" 57mm	16.5" 419mm	79 lbs. 36 kg

7.5 Ton Forklift Jack - 7.5 Ton Lifting Capacity

Model #10437



MODEL 10437



- ▶ The solution for heavy duty forklifts.
- ▶ Handles larger forklifts found in heavy industrial shops.

FORKLIFT SUPPORT STANDS AVAILABLE:
Refer to Page 88

Lifting Capacity	Min. Height	Max. Height	Weight
7.5 Tons 15,000 lbs.	2.25" 57mm	16.5" 419mm	104 lbs. 47 kg

20 Ton Air/Manual Bottle Jack

Model #10446



MODEL 10446

- ▶ Welded base and cylinder to assure strength and eliminate leaks.
- ▶ Chrome-plated pump piston and ram for added rust resistance.
- ▶ Extension screw gives added height when necessary.
- ▶ Return Springs for Faster descent.

Lifting Capacity	Min. Height	Max. Height	Weight
20 Ton	9.625" 245mm	18.75" 476mm	35 lbs. 16 kg

20 Ton Air/Manual Bottle Jack

Model #10450



MODEL 10450

- ▶ Screw on Base
- ▶ Chrome-plated pump piston and ram for added rust resistance.
- ▶ Extension screw gives added height when necessary.
- ▶ Return Springs for Faster descent.

Lifting Capacity	Min. Height	Max. Height	Weight
20 Ton	10.3" 262mm	19.2" 488mm	35 lbs. 16 kg

20 Ton Air Hydraulic Bottle Jack - Shorty

Model #10399



MODEL 10399

- ▶ Shorter Bottle Jack for Low Profile Application.
- ▶ Base and cylinder are welded for increased strength and to eliminate leaks.
- ▶ Air operation lift up to 20 tons.
- ▶ Chromed ram for added rust resistance.
- ▶ Extension screw gives added height when necessary.
- ▶ Low height for easy access.

Capacity	Min. Height	Max. Height	Weight
20 Ton	5.83" 148mm	10.25" 260mm	21 lbs. 9.5 kg

20 Ton Air Hydraulic Cart Jack

Model #10447



MODEL 10447

- ▶ Welded base and cylinder to assure strength and eliminate leaks
- ▶ Chrome-plated pump piston and ram for added rust resistance
- ▶ Extension screw gives added height when necessary

Capacity	Min. Height	Max. Height	Weight
20 Ton	10" 254mm	19" 483mm	51 lbs. 23 kg

22 Ton Air Hydraulic Service Jack - Pro Series

Model #10390



- ▶ Strong more durable handle with Air Ascend/Descend functions built into the handle.
- ▶ Rubber coated handle grips for better handling and comfort.
- ▶ 3-Spring Design - Makes Descending of the jack quicker and more controlled.
- ▶ 22 Ton Capacity
- ▶ 3.35 in. extension screw
- ▶ Minimum Starting Height: 8.5 in.
- ▶ Maximum Height (w/included Extensions): 21.35 in.
- ▶ Includes: 0.75 in.; 2 in.; 4 in. extensions

EXTENSIONS

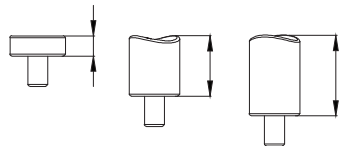

0.75 in. - 2 in. - 4 in.
20mm - 50mm - 100mm

Point.Scan.Explore.

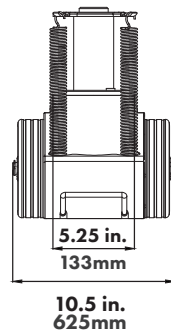
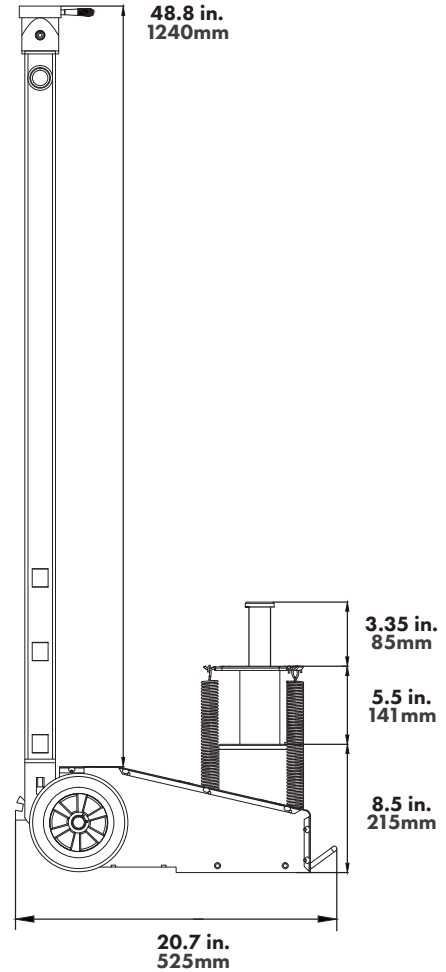

22 Ton Air Hydraulic Service Jack

Model #10448



MODEL 10448

- ▶ Welded base and cylinder to assure strength and eliminate leaks.
- ▶ Chrome-plated pump piston, and ram for added rust resistance.
- ▶ Self-retracting.

Capacity	Min. Height	Max. Height	Weight
22 Ton	8.25" 210mm	20.75" 527mm	90 lbs. 41 kg

* Includes 3 Extensions: 1", 2", and 4"

22/11 Ton Air Hydraulic Jack - Standard & Portable Versions



- ▶ Extremely light, compact and efficient.
- ▶ Made up with the best materials on the market, 92000 and 92001 represent the technological leading edge of our product range.
- ▶ The high quality materials used keep 92001 within 31 lbs. 15 kg weight, making it the lightest and most compact jack we ever built.

SPECIFICATIONS:	Model #	92000	92001	92000	92001
	Style	YAK 214/N	YAK 214/P	YAK 214/N	YAK 214/P
Capacity		22/11 Ton 20/10 Tonne	22/11 Ton 20/10 Tonne	A	38.58" 980 mm
Net Weight		38.5 lbs. 17.5 kg	31 lbs. 15 kg	B	17.32" 440 mm
Working Air Pressure		116-145 psi 8-10 bar	116-145 psi 8-10 bar	C	16.54" 420 mm
				D	5.51" 140 mm
				E	12.05" 306 mm
				F	3.15" 80 mm
				G	3.39" 86 mm
				H	9.06" 230 mm
				K	5.51" 140 mm

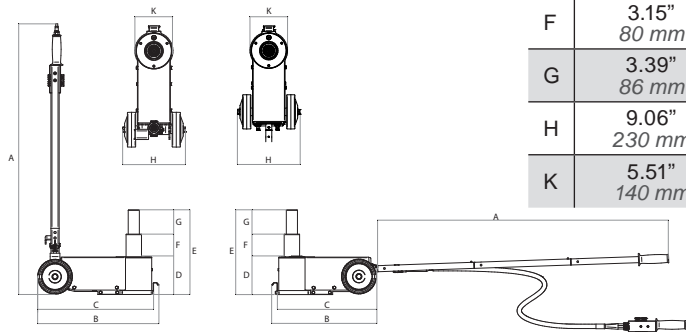

2 Stage Jacks - Low Profile Jack

Model 92002



- ▶ Air hydraulic jack for heavy vehicles, practical and easy to handle.
- ▶ The pistons move back automatically; the two descent valves guarantee perfect holding in all situations and controlled speed under load.
- ▶ Designed especially to meet the specific needs of heavy vehicles with pneumatic suspensions of the latest generation for jobs where a compact size and power are a must.

SPECIFICATIONS:	Model #	92002	92002
	Style	YAK 215/L	YAK 215/L
Capacity		44/22 Ton 40/20 Tonne	A
Net Weight		86 lbs. 39 kg	B
Working Air Pressure		116-145 psi 8-10 bar	C
			D
			E
			F
			G
			H
			K
			L
			M
			N
			O
			P

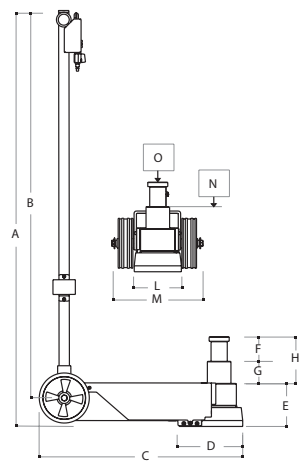

MODEL 92002

44/22 Ton Air Hydraulic HD Jacks



- ▶ Air hydraulic jack for heavy vehicles, practical and easy to handle.
- ▶ The pistons move back automatically; the two descent valves guarantee perfect holding in all situations and controlled speed under load.
- ▶ Ideal for workshops, mobile workshops, tire repairers and bodywork shops.

SPECIFICATIONS:

Model Style	92003 YAK 215/N	92004 YAK 221/N
Capacity	44/22 Ton 40/20 Tonne	44/22 Ton 40/20 Tonne
Net Weight	86 lbs. 39 kg	101 lbs. 46 kg
Working Air Pressure	116-145 psi 8-10 bar	116-145 psi 8-10 bar
A	55.12" 1400 mm	55.12" 1400 mm
B	51.97" 1320 mm	51.97" 1320 mm
C	20.67" 525 mm	20.67" 525 mm
D	10.63" 270 mm	10.63" 270 mm
E	5.91" 150 mm	8.54" 217 mm
F	3.07" 78 mm	4.96" 126 mm
G	2.83" 72 mm	4.88" 124 mm
H	5.91" 150 mm	9.84" 250 mm
K	8.11" 206 mm	8.11" 206 mm
L	11.81" 300 mm	11.81" 300 mm
M	22 Ton 20 Tonne	22 Ton 20 Tonne
N	44 Ton 40 Tonne	44 Ton 40 Tonne

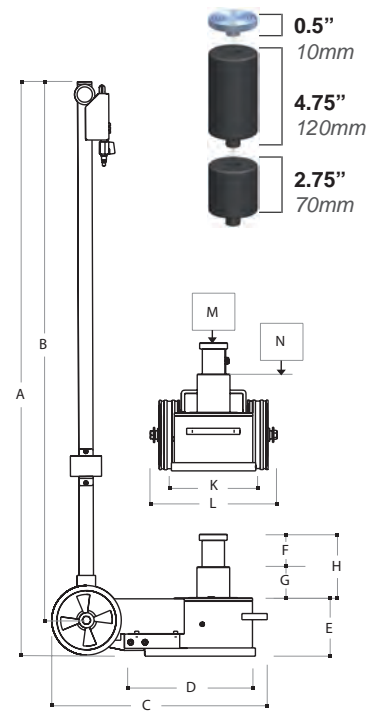

44/22 Ton Portable Jack - w/ Removable Handle

Model #92005



MODEL 92005



Air hydraulic jacks for heavy vehicles, lightweight and easy to handle, with removable handle. The pistons move back automatically; the two descent valves guarantee perfect holding in all situations and controlled speed under load. Our portable series par "excellence", all the reliability and practicality of our jacks in a more compact version. Ideal for keeping on board the vehicle and for who provides road assistance. They can work with the vehicles' own compressors. Extensions Includes: 0.5", 4.75", & 2.75"

SPECIFICATIONS:

Model # Style	92005 YAK 217/P
Capacity	44/22 Ton 40/20 Tonne
Net Weight	82 lbs. 37 kg
Working Air Pressure	116-145 psi 8-10 bar

A	43.31" 1100 mm	E	6.69" 170 mm	K	8.11" 206 mm
B	38.78" 985 mm	F	3.46" 88 mm	L	11.81" 300 mm
C	19.7" 500 mm	G	3.27" 83 mm	M	22 Ton 20 Tonne
D	10.63" 270 mm	H	6.73" 171 mm	N	44 Ton 40 Tonne

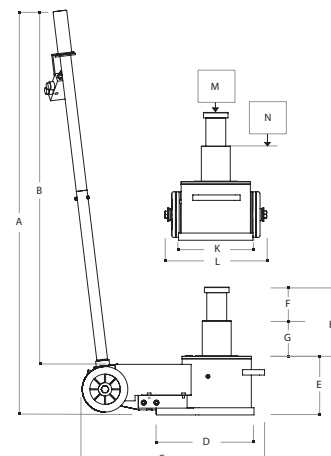

66/33 Ton - High Tonnage 2 Stage Long Style Jack

Model #92006



MODEL 92006

- ▶ Air hydraulic jack for heavy vehicles, practical and effective.
- ▶ The pistons move back automatically; the two descent valves guarantee perfect holding in all situations and controlled speed under load.
- ▶ A complete range of jacks for all stroke and capacity requirements. Ideal for workshops, tire repairers and bodywork shops.

SPECIFICATIONS:

Model #	92006
Style	YAK 222/N
Capacity	66/33 Ton <i>60/30 Tonne</i>
Net weight	157 lbs. <i>71 kg</i>
Working Air Pressure	116-145 psi <i>8-10 bar</i>

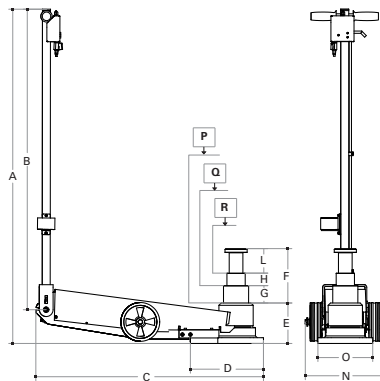

A	56.30" 1430 mm
B	51.97" 1320 mm
C	39.37" 1000 mm
D	12.6" 320 mm
E	8.66" 220 mm
F	9.06" 230 mm
G	4.33" 110 mm
H	4.72" 120 mm
L	NA
N	13.78" 350 mm
O	9.45" 240 mm
P	66 Ton 60 Tonne
Q	33 Ton 30 Tonne
R	NA



3 Stage 66/33/17 Ton Jack - Low Profile Jack

Model #92007

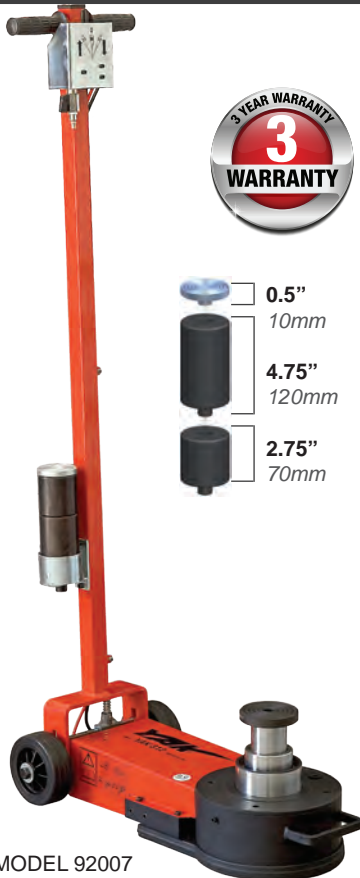

MODEL 92007

Air-hydraulic jacks with pistons moving back automatically. Specifically designed for lifting buses and all vehicles with low profile axles.

SPECIFICATIONS:

Model #	92007
Style	YAK 312
Capacity	66-33-17 Ton <i>60-30-15 Tonne</i>
Net Weight	110 lbs. <i>50 kg</i>
Working Air Pressure	116-145 psi <i>8-10 bar</i>

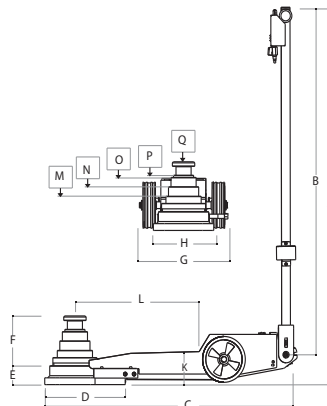

A	54.53" 1385 mm
B	51.77" 1315 mm
C	26" 660 mm
D	13" 330 mm
E	4.74" 120 mm
F	5.31" 135 mm
G	11.81" 300 mm
H	9.84 in 250 mm
K	NA
L	NA
M	66 Ton 60 Tonne
N	33 Ton 30 Tonne
O	17 Ton 15 Tonne
P	NA
Q	NA



33 Ton Jack - Tall Lifting Jack Great for Tractor Service

Model #92008



- ▶ Air hydraulic jacks for heavy vehicles, practical and effective.
- ▶ The pistons move back automatically; the two descent valves guarantee perfect holding in all situations and controlled speed under load. 92008 Ideal for agricultural and public works vehicles.
- ▶ Fitted with roll-over protection plate and, on request, pneumatic wheels for working on particular difficult terrain.



MODEL 92008

SPECIFICATIONS:

Model #	92008
Style	YAK 135
Capacity	33 Ton 30 Tonne
Net Weight	126 lbs. 57 kg
Working Air Pressure	116-145 psi 8-10 bar

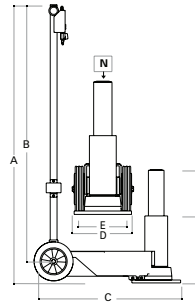
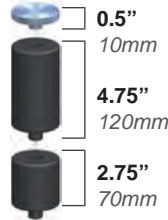

A	55.71" 1415 mm
B	51.77" 1315 mm
C	28.54" 725 mm
D	10.83" 275 mm
E	9.84" 250 mm
F	13.78" 350 mm
G	9.06" 230 mm
N	30 Ton 33 Tonne



3 Stage Long Service Jack - 50/30/15 Ton Capacity

Model #10771

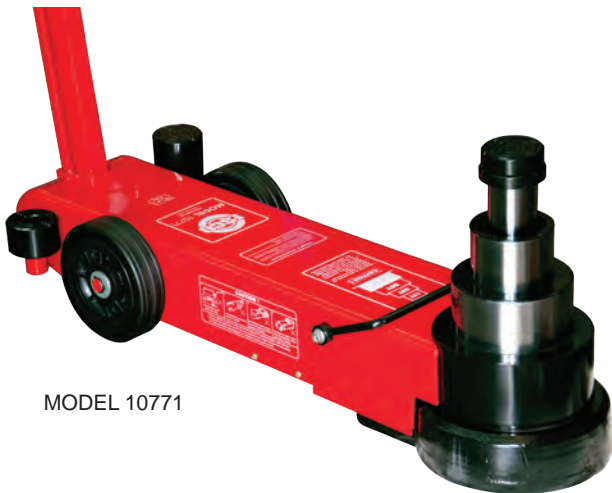

MODEL 10771

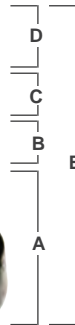

- ▶ Designed for lifting Low Buses and other Low clearance vehicles.
- ▶ Maximum Stability.
- ▶ Convenient Usage.
- ▶ 3 Stages 50T/30T/15T

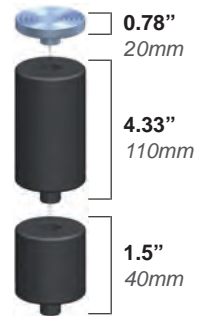

Stage Tonnage	A	B	C	D	E*	Weight
50/30/15T	5.5" 140mm	2.2" 56mm	2" 51mm	2.2" 56mm	11.9" 302mm	143 lbs. 65 kg

* Maximum Height Without Extensions

4 Stage 88/55/28/17 Ton Jack - Low Profile Jack

Model #92010



MODEL 92010



- ▶ Air hydraulic jack for heavy vehicles, practical and effective.
- ▶ The pistons move back automatically; the two descent valves guarantee perfect holding in all situations and controlled speed under load.
- ▶ A complete range of jacks for all stroke and capacity requirements. Ideal for workshops, tire repairers and bodywork shops.

SPECIFICATIONS:

Model #	92010
Style	YAK 418/N
Capacity	88-55-25-17 Ton 80-50-28-15 Tonne
Net weight	170 lbs. 77 kg
Working Air Pressure	116-145 psi 8-10 bar

A	56.30" 1430 mm
B	51.97" 1320 mm
C	39.37" 1000 mm
D	12.6" 320 mm
E	7.09" 180 mm
F	11.81" 300 mm
G	2.56" 65 mm
H	2.83" 72 mm
L	2.83" 72 mm
M	3.58" 91 mm
N	13.78" 350 mm
O	9.5" 240 mm
P	88 Ton 80 Tonne
Q	55 Ton 50 Tonne
R	28 Ton 25 Tonne
S	17 Ton 15 Tonne

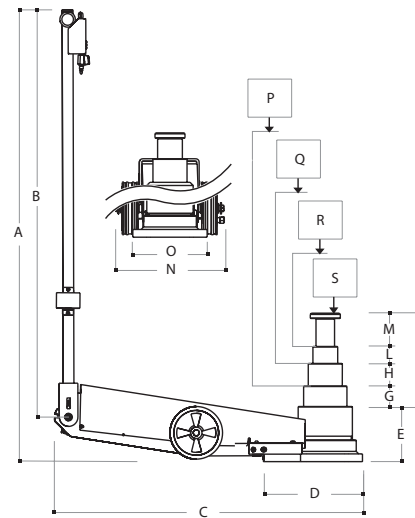

5 Ton Performance Axle Post Jack Stands

Model #10472



MODEL 10472

- ▶ Comes as a pair
- ▶ 5 adjustable height positions
- ▶ Conventional axle saddle
- ▶ Anodized finish
- ▶ New foot design for better stability



Model #	Capacity	Min. Hgt.	Max. Hgt.	Weight
10472	5 Ton Per Stand (10 Tons Total)	13" 330mm	21.5" 546mm	35 lbs. 16 kg

Forklift Style Jack Stands - 13 Ton Per Pair

Model #10436



MODEL 10436



- ▶ Works on all models of forklifts
- ▶ 13 Ton Capacity Per Pair
- ▶ Rugged steel construction
- ▶ Safety lock ring on adjustment pin
- ▶ Sold as a Set

FORKLIFT JACKS AVAILABLE:
Refer to Page 80 to See Forklift Jacks

Model #	Capacity	Min. Hgt.	Max. Hgt.	Weight
10436	13 Ton Per Pair	9.5" 241mm	16" 406mm	28 lbs. 13 kg

3 Ton Performance Jack Stand - 3 Ton Capacity Per Stand

Model #10498



MODEL 10498

AVAILABLE:
10498K - Comes with 10498 &
10497 Axle Top Post



MODEL 10498K

- ▶ **Removable Rubber Flat Top INCLUDED**
- ▶ 3 Ton Capacity per stand
- ▶ 0.7" | 18mm & 1.4" | 35mm position adjustments
- ▶ 10 Adjustable Positions.
- ▶ Circular base pads for maximum stability
- ▶ Best jack stand design on the market
- ▶ Powder coated base prevents rusting
- ▶ European design
- ▶ Sold Per Stand

Model #	Capacity	Min. Hgt.	Max. Hgt.	Weight
10498	3 Ton	13.2" 335mm	21.5" 546mm	11.4 lbs. 5.2 kg

3 Ton Performance Jack Stand - Axle Top Post

Model #10497



MODEL 10497

- ▶ 3 Ton Capacity per stand
- ▶ 0.7" | 18mm & 1.4" | 35mm position adjustments
- ▶ 10 Adjustable Positions
- ▶ Conventional axle saddle
- ▶ Circular base pads for maximum stability
- ▶ Best jack stand design on the market
- ▶ Powder coated base prevents rusting
- ▶ European design
- ▶ Sold Per Stand

Model #	Capacity	Min. Hgt.	Max. Hgt.	Weight
10497	3 Ton	13.2" 335mm	21.5" 546mm	11.4 lbs. 5.2 kg

3 Ton Performance Jack Stand - Shorty Style

Model #10499



MODEL 10499



- ▶ Similar to the 10498 with a shorter base and post
- ▶ Great for Low Profile Vehicles
- ▶ 3 Ton Capacity per stand (6 Ton Per Set)
- ▶ 0.7" | 18mm & 1.4" | 35mm position adjustments
- ▶ 7 Adjustable Positions
- ▶ Conventional axle saddle
- ▶ Sold Per Stand

Model #	Capacity	Min. Hgt.	Max. Hgt.	Weight
10499	3 Ton	11" 280mm	17" 432mm	11 lbs. 5 kg

10 Ton High Lift Jack Stand - Spring Assisted

Model #10493



Designed to provide extra heavy-duty support on raised vehicles. The High-Lift Jack Stand has a spring assisted shaft and up to 11 total adjustable pin positions for precise height. Also included is a adjustable lifting pad to support the load. With three spring loaded caster wheels, movability is simple and easy. The folding tripod design makes for easy storage.

- 1** Spring assisted main shaft for safe and easy positioning.
- 2** Foldable tripod stand designed for easy storage.
- 3** Easy to assemble with no tools needed.
- 4** Easy to maneuver through workshop

- ▶ A lifting capacity of up to 10 Tons (20,000 lbs.).
- ▶ Adjustable pin selections for precise height.
- ▶ Adjustable screw lifting pad for added height.
- ▶ Ideal for repairs on transmissions, engines, exhaust systems and more.

MODEL 10493

Capacity	Min. Hgt.	Max. Hgt.	Saddle Hgt.
10 Tons 20,000 lbs.	43" 1096mm	69.25" 1759mm	2.5" 65mm
Saddle Width	Overall Width	Total Adjustments	Weight
4.5" 108mm	38.4" 975mm	11 Positions	200 lbs. 90 kg



Spring Assisted Main Shaft With Adjustable Pin Positions.



(3) Three-Spring Loaded Caster Wheels Make It Easy To Move.

22 Ton Jack Stands



Model # Style	92019 AS 20-048	92020 AS 20-073	92021 AS 20-120
Capacity	22 Ton 20 Tonne	22 Ton 20 Tonne	22 Ton 20 Tonne
Net Weight	30 lbs. 13.5 kg	41 lbs. 18.5 kg	66 lbs. 30kg
A	13.75" 350mm	17.32" 440mm	26.75" 680mm
B	12.25" 310mm	17.50" 445mm	27.36" 695mm
C	18.9" 480mm	16.61" 422mm	47.25" 1200mm
D	3	5	8
WHEELS	N	N	Y

SPECIFICATIONS:

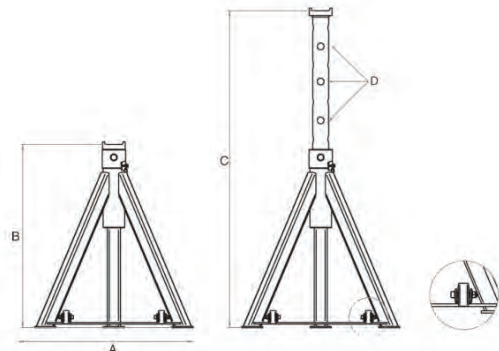

20 Ton Screw Style Jack Stands



MODEL 10802 & 10803

- 1 Swivel Style Jack Stand for Precision Lift Support
- 2 Easy to Turn Handle - Allows for Accurate Height Extension
- 3 Lifting Handle for Ergonomic Movement of Jack Stands
- 4 Wide Base - Better Stability & Surface Area for Jack Support

- ▶ Quality Built Professional Screw Style Jack Stand
- ▶ Screw Style Stand makes it Easy to Hold Load at Desired Height and Secure with Locking Collar
- ▶ Adjustable Screw for Height Extension and Retraction
- ▶ Heavy Duty Design and Application
- ▶ 20 Ton Capacity Per Stand
- ▶ 13" x 13" | 330mm x 330mm Base
- ▶ Sold Per Stand

Model #	Capacity	Min. Hgt.	Max. Hgt.	Weight
10802	20 Tons	16.5" 420mm	26.5" 673mm	65 lbs. 29 kg
10803	20 Tons	26" 661mm	46" 1169mm	82 lbs. 37 kg

25 Ton Pin Style Jack Stands



MODEL 10804 & 10805

- 1 Pin Style Jack Stand
- 2 6 Position Lifting Stand
- 3 Heavy Duty Steel Design - Will Withstand Constant Usage
- 4 Reinforced Welded Brackets to Support Load

- ▶ Reinforced High Stand with Controlled Pin Holes
- ▶ Easy to Use Pin Adjustable Height
- ▶ Quality Design and Support Bracing to Sustain Heavy Loads
- ▶ 13" x 13" | 330mm x 330mm Base
- ▶ 25 Ton Capacity Per Stand
- ▶ Sold Per Stand

Model #	Capacity	Min. Hgt.	Max. Hgt.	Weight
10804	25 Tons	27" 686mm	41" 1050mm	79 lbs. 36 kg
10805	25 Tons	15.75" 400mm	26.75" 680mm	51 lbs. 23 kg

22 Ton Pin Style Jack Stand - Short Style

Model #10455























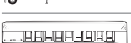









MODEL 10455

- ▶ The 10455 Jack Stand is used for fleet and maintenance garages
- ▶ Pin type support column adjusts to three different axle height positions
- ▶ Adjustment pin is secured to stand to prevent loss
- ▶ Handle provides ease of positioning and carrying
- ▶ 3/8" thick solid steel base plate for added stability
- ▶ Maximum Capacity of 22 Tons Per Stand
- ▶ Sold Per Stand

Model #	Capacity	Min. Hgt.	Max. Hgt.	Weight
10455	22 Tons	14" 356mm	20" 508mm	34 lbs. 16 kg



JACK APPLICATION GUIDE

	92013 YAK 203	92014 YAK 203/C	92016 YAK 109/C	92015 CANGURO	92007 YAK 312	92005 YAK217/P	92000 YAK214/W	92001 YAK214/P	92002 YAK215/L	92003 YAK215/W	92004 YAK221/W	92009 YAK300	92010 YAK418/W	92006 YAK222/W	92008 YAK135
				•											
				•											
	•	•	•												
	•	•	•												
	•	•	•												
	•	•	•												
	•	•	•												
			•												
						•	•	•	•	•	•	•	•	•	
													•	•	
													•	•	
													•	•	
						•	•	•	•	•	•	•	•	•	
						•	•	•	•	•	•	•	•	•	
						•	•	•	•	•	•	•	•	•	
						•	•	•	•	•	•	•	•	•	
					•		•	•	•	•					
					•		•	•	•	•					
					•		•	•	•	•					
						•	•	•	•	•	•	•	•	•	
						•	•	•	•	•	•	•	•	•	
				•											•
				•							•	•			•
				•											
				•											
				•							•	•	•	•	•
											•	•	•	•	•
													•	•	•
													•	•	•
													•	•	•
													•	•	•

JACK APPLICATIONS ARE BASED ON SUGGESTION. APPLICATION MAY VARY. PLEASE CONSULT WITH A ESCO SALES REPRESENTATIVE FOR MORE INFORMATION.



BALANCING BEADS APPLICATION CHART

TIRE SIZE	ESCO BEADS	TIRE SIZE	ESCO BEADS	TIRE SIZE	ESCO SIZE	TIRE SIZE	ESCO BEADS
14"		225/65R16	3 oz.	235/60R17	3 oz.	285/50R18	3 oz.
205/70 R14	3 oz.	245/65R16	3 oz.	255/60R17	4 oz.	375/50R18	4 oz.
215/70 R14	3 oz.	255/65R16	3 oz.	275/60R17	4 oz.	255/55R18	3 oz.
215/75 R14	3 oz.	305/65R16	4 oz.	285/60R17	4 oz.	275/55R18	3 oz.
15"		345/65R16	4 oz.	265/65R17	4 oz.	285/55R18	3 oz.
700R15	3 oz.	375/65R16	5 oz.	305/65R17	4 oz.	245/60R18	3 oz.
7.50R15	4 oz.	215/70R16	3 oz.	375/65R17	6 oz.	255/60R18	3 oz.
8.25R15	6 oz.	225/70R16	3 oz.	225/65R17	3 oz.	265/60R18	3 oz.
9R15	6 oz.	235/70R16	3 oz.	235/65R17	3 oz.	275/60R18	4 oz.
10R15	8 oz.	245/70R16	3 oz.	245/65R17	3 oz.	285/60R18	4 oz.
1000R15	8 oz.	255/70R16	4 oz.	255/65R17	3 oz.	325/60R18	4 oz.
225/60R15	3 oz.	265/70R16	3 oz.	245/70R17	6 oz.	375/60R18	6 oz.
325/60R15	3 oz.	275/70R16	4 oz.	255/70R17	6 oz.	395/60R18	6 oz.
245/65R15	3 oz.	305/70R16	3 oz.	265/70R17	4 oz.	275/65R18	4 oz.
235/70R15	3 oz.	315/70R16	4 oz.	275/70 R17	6 oz.	285/65R18	4 oz.
245/70R15	3 oz.	355/70R16	5 oz.	285/70R17	6 oz.	325/65R18	4 oz.
255/70R15	3 oz.	365/70R16	5 oz.	305/70R17	6 oz.	355/65R18	4 oz.
265/70R15	3 oz.	395/70R16	5 oz.	315/70R17	6 oz.	395/65R18	6 oz.
285/70R15	4 oz.	175/75R16	3 oz.	355/70R17	6 oz.	255/70R18	3 oz.
315/70R15	3 oz.	195/75R16	3 oz.	235/75R17	6 oz.	265/70R18	3 oz.
195/75R15	3 oz.	225/75R16	3 oz.	245/75R17	6 oz.	275/70R18	4 oz.
205/75R15	3 oz.	235/75R16	3 oz.	255/75R17	6 oz.	19"	
215/75R15	3 oz.	245/75R16	3 oz.	285/75R17	6 oz.	275/45R19	3 oz.
225/75R15	3 oz.	265/75R16	4 oz.	235/80R17	6 oz.	285/45R19	3 oz.
235/75R15	3 oz.	285/75R16	4 oz.	17.5"		255/50R19	3 oz.
245/75R15	3 oz.	315/75R16	4 oz.	8R17.5	4 oz.	255/55R19	3 oz.
255/75R15	3 oz.	295/75R16	4 oz.	8.5R17.5	6 oz.	19.5"	
265/75R15	3 oz.	205/80R16	3 oz.	9 R17.5	6 oz.	8R19.5	8 oz.
215/80R15	3 oz.	325/80R16	4 oz.	9.5R17.5	6 oz.	9R19.5	8 oz.
15.5"		215/85R16	3 oz.	10R17.5	8 oz.	18R19.5	13 oz.
185/70R15.5	3 oz.	225/85R16	3 oz.	11R17.5	8 oz.	425/44 R19.5	14 oz.
16"		235/85R16	3 oz.	195/60R17.5	3 oz.	445/45 R19.5	12 oz.
6.5R16	4 oz.	245/85R16	3 oz.	205/60R17.5	8 oz.	435/50 R19.5	10 oz.
7.50R16	3 oz.	255/85R16	4 oz.	225/60R17.5	3 oz.	385/65R19.5	13 oz.
8.25R16	6 oz.	265/85R16	4 oz.	195/70R17.5	4 oz.	445/65R19.5	16 oz.
9.00 R16	6 oz.	275/85R16	4 oz.	215/70R17.5	4 oz.	225/70R19.5	6 oz.
11R16	10 oz.	16.5"		235/70R17.5	4 oz.	245/70R19.5	8 oz.
245/50R16	3 oz.	8R16.5	3 oz.	245/70R17.5	5 oz.	265/70R19.5	8 oz.
255/55R16	3 oz.	8.75R16.5	3 oz.	265/70R17.5	5 oz.	275/70R19.5	8 oz.
315/55R16	3 oz.	9.50R16.5	4 oz.	205/75R17.5	6 oz.	285/70R19.5	8 oz.
345/55R16	3 oz.	10R16.5	6 oz.	215/75R17.5	4 oz.	305/70R19.5	10 oz.
355/55R16	3 oz.	12R16.5	8 oz.	225/75R17.5	4 oz.	285/75R19.5	10 oz.
375/55R16	4 oz.	17"		235/75R17.5	6 oz.	280/75R19.5	8 oz.
215/60R16	3 oz.	255/50R17	3 oz.	245/75R17.5	6 oz.		
225/60R16	3 oz.	225/55R17	3 oz.	205/80R17.5	4 oz.		
235/60R16	3 oz.	255/55R17	3 oz.	225/80R17.5	4 oz.		
285/60R16	3 oz.	275/55R17	3 oz.	225/90R17.5	6 oz.		
195/65R16	3 oz.	345/55R17	3 oz.	18"			
215/65R16	3 oz.	225/60R17	3 oz.	7.50R18	8 oz.		



































NOTE: THIS IS NOT A COMPLETE LIST OF TIRE SIZES AND APPLICATIONS.

FOR MORE TIRE APPLICATIONS AND SIZES PLEASE VISIT WWW.ESCO.NET OR SCAN THE QR CODE





BEAD BREAKER & PUMP CHART

BEAD BREAKER APPLICATION GUIDE

										
		10508	10876	10590	10500	10502	10592	10877	10875	10504
		NA	NA	10201	10200	NA	10202	10839	10825	NA
		NA	NA	NA	10230	NA	10237	10821	10820	NA
		NA	NA	NA	10221	NA	10233	10841	10826	NA
		NA	NA	NA	10221	NA	10233	10841	10826	NA
		NA	NA	NA	10228	NA	10220	10847	10832	NA
		NA	NA	NA	10229	NA	10223	10848	10837	NA
		10213*	NA	10206	10205	NA	10222	10844	10829	NA
		10204*	NA	10208	10207	NA	10209	10838	10824	NA
		NA	NA	NA	10231	NA	10238	10823	10822	NA
		10224*	NA	NA	10212	NA	10235	10843	10828	NA
		NA	NA	NA	10227	NA	10234	10842	10827	10211
		NA	NA	NA	10203	NA	10236	10845	10830	NA

*10601K NOT INCLUDED

BEAD BREAKER APPLICATION GUIDE

-  - SINGLE PIECE RIM
-  - 2 PIECE RIM
-  - 3 PIECE RIM
-  - 5 PIECE RIM
-  - ALL WHEEL ASSEMBLIES



BEAD BREAKER KITS COME WITH:

- 10604 - 8 ft. Hose assembly (10610) with Hose Coupler (10605)
- 10601K - Air Reducer & 6" Whip Hose

BEAD BREAKER & PUMP APPLICATION CHART IS BASED ON CONFIGURATION NOT BY RECOMMENDED USAGE. PLEASE CONSULT WITH AN ESCO SALES REPRESENTATIVE FOR MORE INFORMATION ABOUT APPLICATION & KIT CONFIGURATIONS.









Rim Size	Tire Size	Bead Breaker	
8	18 X 6.50-8	70150, 20429, 70160	
	18 X 8.50-8	70150, 20429, 70160	
	18 X 9.50-8	70150, 20429, 70160	
	20 X 8.00-8	70150, 20429, 70160	
	20 X 14-8	70150, 20429, 70160	
10	21 X 11.00-8	70150, 20429, 70160	
	23 X 9.50-10	70150, 20429, 70160	
	26 X 12.00-10	70150, 20429, 70160	
12	12.5L-12	70150, 20429, 70160	
	23 X 8.50-12	70150, 20429, 70160	
14	9.5L-14	70150, 20429, 70160	
	11L-14	70150, 20429, 70160	
15	5.00-15	70150, 20429, 70160	
	5.90-15	70150, 20429, 70160	
	6.70-15	70150, 20429, 70160	
	7.5L-15	70150, 20429, 70160	
	9.5L-15	70150, 20429, 70160	
	11L-15	70150, 20429, 70160	
	12L-15	70150, 20429, 70160	
	12.5L-15	70150, 20429, 70160	
	27X10.5-15	70150, 20429, 70160	
	27X8.50-15	70150, 20429, 70160	
	29 X 12.00-15	70150, 20429, 70160	
	31 X 15.5-15	70150, 20429, 70160	
	44 X 41.00-15	70150, 20429, 70160	
	15.3	10.0/75R-15.3	70150, 20429, 70160
		11.5/80R-15.3	70150, 20429, 70160
12.5/80R-15.3		70150, 20429, 70160	
16	7.00-16	70150, 20429, 70160	
	8.25-16	70150, 20429, 70160	
	9.5-16	70150, 20429, 70160	
	11.00-16	70150, 20429, 70160	
	11L-16	70150, 20429, 70160	
	12.5L-16	70150, 20429, 70160	
	38 X 20.00-16	70150, 20429, 70160	
	44X41.00-16	70150, 20429, 70160, 10101, 10107, 10895	
16.5	10-16.5	70150, 20429, 70160, 10101, 10107, 10895	
	12-16.5	70150, 20429, 70160, 10101, 10107, 10895	
	14-17.5	70150, 20429, 70160, 10101, 10107, 10895	
17.5	4.00-18	70150, 20429, 70160	
	10.5/80R-18	70150, 20429, 70160, 10101, 10107, 10895	
18	12.5/80-18	10101, 10107, 10895, 70150, 20429, 70160	
	12.5/80R-18	10101, 10107, 10895, 70150, 20429, 70160	
	15-19.5	70150, 20429, 70160, 10101, 10107, 10895	
19.5	40.00-19.5	70150, 20429, 70160, 10101, 10107, 10895	
	7.50-20	70150, 20429, 70160	
20	10.00-20	70150, 20429, 70160, 10101, 10107, 10895	
	12.00-20	70150, 20429, 70160, 10101, 10107, 10895	
	14.00-20	70150, 20429, 70160, 10101, 10107, 10895	
	16.00-20	70150, 20429, 70160, 10101, 10107, 10895	
	18.00-20	70150, 20429, 70160, 10101, 10107, 10895	
	47 X 20.00	70150, 20429, 70160, 10101, 10107, 10895	
	48 X 25.00-20	70150, 20429, 70160, 10101, 10107, 10895	
	11R-22.5	70150, 20429, 70160, 10101, 10107, 10895	
	18.00-22.5	70150, 20429, 70160, 10101, 10107, 10895	
	24	11.25-24	70150, 20429, 70160, 10101, 10107, 10895
		12.00-24	70150, 20429, 70160, 10101, 10107, 10895
		12.4-24	70150, 20429, 70160, 10101, 10107, 10895
14.00-24		70150, 20429, 70160, 10101, 10107, 10895	
14.00R-24		70150, 20429, 70160, 10101, 10107, 10895	
16.00-24		70150, 20429, 70160, 10101, 10107, 10895	
16.9-24		70150, 20429, 70160, 10101, 10107, 10895	
17.5L-24		70150, 20429, 70160, 10101, 10107, 10895	
19.5L-24		70150, 20429, 70160, 10101, 10107, 10895	
21L-24		70150, 20429, 70160, 10101, 10107, 10895	
25	14.00-25	10101, 10102** 10107, 10895	
	15.5-25	10101, 10102** 10107, 10895	
	16.00-25	10101, 10102** 10107, 10895	
	17.5-25	10101, 10102** 10107, 10895	
	17.5R-25	10101, 10102** 10107, 10895	
	18.00-25	10101, 10102** 10107, 10895	
	20.5-25	10101, 10102** 10107, 10895	
	20.5R-25	10101, 10102** 10107, 10895	
	21.00-25	10101, 10102** 10107, 10895	
	23.5-25	10101, 10102** 10107, 10895	
	23.5R-25	10101, 10102** 10107, 10895	
	24.00-25	10101, 10102** 10107, 10895	
	26.5-25	10101, 10102** 10107, 10895	
	26.5R-25	10101, 10102** 10107, 10895	
	29.5-25	10101, 10102** 10107, 10895	
	29.5R-25	10101, 10102** 10107, 10895	
	54x37.00-25	10101, 10102** 10107, 10895	
	66x43.00-25	10101, 10102** 10107, 10895	
	385/95R-25	10101, 10102** 10107, 10895	
	445/95R-25	10101, 10102** 10107, 10895	
505/95R-25	10101, 10102** 10107, 10895		









**3 Piece Rim w/ Extended Flange Requires #10109







Rim Size	Tire Size	Bead Breaker	
26	750/65R-25	10101, 10102** 10107, 10895	
	18-26	10101, 10895, 20429	
28	16.9-28	10101, 10895, 20429	
	21L-28	10101, 10895, 20429	
29	21.00-29	10101, 10895, 20429	
	24.00-29	10100, 10105, 10896, 40600	
	26.50-29	10100, 10105, 10896, 40600	
	26.50-R-29	10100, 10105, 10896, 40600	
	29.50-29	10100, 10105, 10896, 40600	
	29.50-R-29	10100, 10105, 10896, 40600	
	30/65-29	10100, 10105, 10896, 40600	
	33.25-29	10100, 10105, 10896, 40600	
	33.25-R29	10100, 10105, 10896, 40600	
	775-65R-29	10100, 10105, 10896, 40600	
30	800/65R-29	10100, 10105, 10896, 40600	
	875/65R-29	10100, 10105, 10896, 40600	
32	67 X 34.00-30	10101, 10895, 20429	
	24.5x32	10101, 10895, 20429	
33	30.5L-32	10101, 10895, 20429	
	35.5L-32	10101, 10895, 20429	
	18.00-33	10100, 10105, 10896, 40600	
	18.00-R33	10100, 10105, 10896, 40600	
	21.00R33	10100, 10105, 10896, 40600	
	27.00-33	10100, 10105, 10896, 40600	
	30.00-33	10100, 10105, 10896, 40600	
	33.50-33	10100, 10105, 10896, 40600	
	35/65-33	10100, 10105, 10896, 40600	
	35/65R-33	10100, 10105, 10896, 40600	
	36/65-33	10100, 10105, 10896, 40600	
	34	18.4-34-34	10101, 10895, 20429
		21.00-35	10100, 10105, 10896, 40600
	35	21.00R-35	10100, 10105, 10896, 40600
		24-35	10100, 10105, 10896, 40600
21.00-35		10100, 10105, 10896, 40600	
24.00-35		10100, 10105, 10896, 40600	
29.5-35		10100, 10105, 10896, 40600	
33.25-35		10100, 10105, 10896, 40600	
33.25R-35		10100, 10105, 10896, 40600	
37.25-35		10100, 10105, 10896, 40600	
37.25R-35		10100, 10105, 10896, 40600	
30.00-39		10100, 10105, 10896, 40600	
38	33.5-39	10100, 10105, 10896, 40600	
	37.50-39	10100, 10105, 10896, 40600	
	37.50R-39	10100, 10105, 10896, 40600	
	40/65-39	10100, 10105, 10896, 40600	
	40/65R-39	10100, 10105, 10896, 40600	
	40.5/75R-39	10100, 10105, 10896, 40600	
	41.25/70-39	10100, 10105, 10896, 40600	
	41.25/70R-39	10100, 10105, 10896, 40600	
	45/65R-39	10100, 10105, 10896, 40600	
	65/40R-39	10100, 10105, 10896, 40600	
42	1150/65R-39	10100, 10105, 10896, 40600	
	18.4-42	10101, 10895, 20429	
43	20.8-42	10101, 10895, 20429	
45	24.00-43	10100, 10105, 10896, 40600	
	45/65-45	10100, 10105, 10896, 40600	
46	45/65R-45	10100, 10105, 10896, 40600	
	1150/65R-45	10100, 10105, 10896, 40600	
49	18.4R-46	10101, 10895, 20429	
	18.00-49	10100, 10105, 10896, 40600	
	21.00-49	10100, 10105, 10896, 40600	
	24.00-49	10100, 10105, 10896, 40600	
	24.00R-49	10100, 10105, 10896, 40600	
	27.00-49	10100, 10105, 10896, 40600	
	27.00R-49	10100, 10105, 10896, 40600	
	36.00-49	10100, 10105, 10896, 40600	
	320/90R-50	10101, 10895, 20429, 70150, 70160	
	380/90R-50	10101, 10895, 20429, 70150, 70160	
51	30.00-51	10100, 10105, 10896, 40600	
	30.00R-51	10100, 10105, 10896, 40600	
	33.00-51	10100, 10105, 10896, 40600	
	33.00R-51	10100, 10105, 10896, 40600	
	36.00-51	10100, 10105, 10896, 40600	
	36.00R-51	10100, 10105, 10896, 40600	
	37.5-51	10100, 10105, 10896, 40600	
	50-65R-51	10100, 10105, 10896, 40600	
	37.00-57	10103, 40601, 40602	
	37.00R-57	10103, 40601, 40602	
57	40.00R-57	10103, 40601, 40602	
	40.00-57	10103, 40601, 40602	
	46/90R-57	10103, 40601, 40602	
	50/80-57	10103, 40601, 40602	
	52/80-57	10103, 40601, 40602	
	52/80R-57	10103, 40601, 40602	
	40.00-63	10103, 40601, 40602	
	55/80R-63	10103, 40601, 40602	
	58/80R-63	10103, 40601, 40602	
	59/80R-63	10103, 40601, 40602	







REMINDER: This application chart is based on recommended usage of tire bead breaking tools on tire/rim sizes and types above and is to be used only as a guide. Not all tire/rim configurations are included. For more information contact your ESCO sales representative. ESCO is not liable for the misuse or improper use of any and/or all ESCO Equipment. Please speak to an ESCO representative for proper training on all ESCO products.







	28705	34184	36958	10100RK	58449YE3	DA11816049
						
Earthmover Bead Breaker	Pressure Nut	Set Screw	Hook	Repair Kit	Clevis	Retaining Clip

	10701	36853	202636	204238	306135	420438	B1069028	B1139028
								
Combi Style Bead Breaker	Repair Kit	Claw	T-Handle	Bushing	Replaceable Teeth	Clamp	Cap Screw for Clamp	Cap Screw for Teeth









	10701	36853L	202636	204238	306135L	420438L	B1069028	B1139028
								
Maxi Bead Breaker	Repair Kit	Claw Long	T-Handle	Bushing	Replaceable Teeth	Clamp	Cap Screw for Clamp	Cap Screw for Teeth

	RC-102K	TO-100-18	TO-100-19	TO-100-23	TO-100-44	TO-100-14
						
Earthmover Bead Breaker	Repair Kit	Trunion	Spade	Wedges	Adapter	T-Handle







	28705	DA11663157	DA11816049	RC2510K	34184	10103-3
						
Earthmover Bead Breaker	Pressure Nut	Hook	Retaining Ring	Repair Kit	Set Screw	Adapter





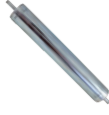

	300444	302651	10300	10301	G382107	G385044	RC102K
							
100 Ton Cylinder	Repair Kit	Saddle	10 Ton Short Ram	Rod Bearing	Stop Ring	Repair Kit	

	RCS302K	10306	10308	10313	RCA502K	U962127045
						
30 Ton Short Ram	Repair Kit	55 Ton Cylinder	Valve Assembly	Repair Kit	Saddle	







	10312-VP	10312-15	10312-RK		20429-8	20429-10	20429-14
							
55 Ton Cylinder	Valve Assembly	Saddle	Repair Kit	Pneumatic Bead Breaker	Wedge Foot	Grapple Hook	Drive Bolt for Hook





	DA4849218	DC2234900SR	DC3913900SR	DC4027167	DC4321900SR	PAT1102K1
						
3.5 Quart Hyd. Pump	Treadle	Repair Kit, Air Side	Cover Assembly	Cover Gasket	Reservoir Assembly	Repair Kit, Hydraulic Side

	46271	41322	300831		LA206A	LA213
						
5 Quart Hyd. Pump	Cover Gasket	Foot Pedal	Repair Kit	Wheel Dolly	Roller	Wheels

	10446-AMK	10446-CK	10446-28		70190	LA213
						
20 Ton Bottle Jack	Air Motor Kit	Cylinder Kit	Hose Assembly	Super-Single Wheel Dolly	Roller	Wheels

	10448-AMK	10448-CK	10448-1.2		10435-RKB
					
20 Ton Bottle Jack	Air Motor Kit	Cylinder Kit	Wheels	Forklift Jack	Repair Kit

	20408-2	20408-4	20408-7		10437-RK
					
Universal Demount Tool	Screw Assembly	Push Foot Assembly	Heel Protector Kit (w/ Screws)	Forklift Jack	Repair Kit

	RED-70208-2	WHITE-70208-3	BLUE-70208-4	BLACK-70208-6
				
Tuffbar	Front Plate	Center Plate	Rear Plate	Bottom Back Plate

AUTHORIZED ESCO WARRANTY & REPAIR CENTERS

“More Locations to Service ESCO Product & ESCO Customers Needs...”



- ▶ Authorized ESCO Repair & Warranty Centers Located through the US & Canada. *For more information contact your ESCO sales representative.*
- ▶ ESCO will pick up product for repair/warranty at your location.
- ▶ ESCO will guarantee Repair/Service for 30 days.
- ▶ ESCO has rental tools available
- ▶ ESCO repairs IMT, FEC, Stellar, Blackhawk, OTC, Power Team, Ame Int., & Enerpac hydraulic pumps, bead breaker, and cylinders.
- ▶ Technical Support Over the Phone Available by Calling 1-800-352-9852

GUARANTEED 1 Day Turnaround Service.

We Receive 1 Day-Repair-Ship Back To You Next Day

Prompt, reliable service after the sale is very important to ESCO. ESCO maintains an in-house repair facility in Brooksville, Florida. To insure that our customers have as little down-time as possible, we offer a 1 day turnaround service. Our factory repair service is equipped with all the tools and machinery needed to repair our equipment quickly and affordably. Our trained technicians are the best in the industry. Not only do we service our own products, but we also service our competitors' products.

In addition to ESCO's 30 years of providing quality repair service, ESCO has reached out and partnered with more than 50+ hydraulic repair facilities across the US & Canada, to deliver quality repair and timely return of products. Visit www.esco.net or call 1.800.352.9852 to hear more about the newly added “Authorized ESCO Warranty & Repair Facilities” across the US.

If you have a bead breaker, ram, or hydraulic pump that needs repair, ESCO fixes your product with factory parts and guarantees the repair. In addition to servicing ESCO brand products, we also repair CP, IMT, Elrick, Branick, Goodyear, FEC, Ame Int., and Haltec lines of hydraulic bead breakers, rams, pumps, jacks, and many other hydraulic tire service equipment.





MODEL	PG	MODEL	PG	MODEL	PG	MODEL	PG	MODEL	PG	MODEL	PG	MODEL	PG	MODEL	PG		
10001	49	10348	24	10820	8	20396	43	60929	59	91028	27	10448-1.2	96	B1139028	95	TO-100-19	95
10002	49	10349	24	10821	8	20397	47	70100	43	91029	27	10448-AMK	96	BLACK-70208-6	96	TO-100-23	95
10004	49	10350	24	10822	12	20401	45	70130	57	91030	27	10448-CK	96	BLUE-70208-4	96	TO-100-44	95
10006	49	10351	24	10823	12	20402	45	70132	57	91031	27	10498K	88	DA11663157	95	U962127045	95
10007	50	10352	24	10875	18	20403	45	70134	56	91032	27	10501C	17	DA11816049	95	WHITE-70208-3	96
10010	50	10353	24	10876	18	20404	45	70141	46	91033	27	10508HC	19	DA11816049	95		
10015	49	10354	24	10877	18	20405	46	70150	15	91034	27	10540P	65	DA4849218	96		
10017	49	10355	24	10895	8	20406	46		59	91035	27	10593C	18	DC2234900SR	96		
10021	50	10356	24	10896	12	20408	47	70160	15	91036	27	10595C	19	DC3913900SR	96		
10024	49	10357	24	10901	23	20414	47	70162	70	92000	83	10601H	17	DC4027167	96		
10071	86	10390	82	10902	23	20415	47	70163	70	92001	83	10601K	17	DC4321900SR	96		
10100	12	10399	81	10925	66	20416	43	70190	96	92002	83	10807C	20	EJR-100-27	28		
10101	8	10435	80	10926	66	20418	46	70200	60	92003	84	10875C	18	EJR-100-38	28		
10102	9	10436	88	10927	66	20425	16	70201	60	92004	84	10876C	18	EJR-150-27	28		
10103	13	10437	80	10950	35	20429	16	70202	60	92005	84	10877C	18	EJR-150-38	28		
10104	13	10446	81	10951	35	20430	45	70203	60	92006	85	10963-K	40	EJR-200-27	28		
10105	10	10447	81	10952	35	20471	64	70204	60	92007	85	10965-K	41	EJR-200-38	28		
10106	15	10448	81	10953	35	28705	95	70208	60	92008	86	12105K	67	ESC-OR-20JM-CASE	71		
10107	9	10448	82	10960	39	28705	95	70210	60	92010	87	12107K	67	ESC-OR-215T-CASE	71		
10108	16	10450	81	10961	39	30100	53	90100	68	92011	74	12109K	67	ESC-OR-217L-CASE	71		
10109	10	10455	90	10962	40	30120	53	90200	68	92012	74	12112K	67	ESC-OR-21T-CASE	71		
10200	8	10472	87	10963	40	30121	53	90300	69	92013	74	12113K	67	ESC-OR-220TG-CASE	71		
10201	8	10493	89	10964	41	30125	53	90400	69	92014	74	20408-2	96	ESC-OR-224TG-CASE	71		
10202	8	10497	88	10965	41	34184	95	90401	69	92017	74	20408-4	96	ESC-OR-225T-CASE	71		
10203	15	10498	88	10966	40	34184	95	90402	69	92018	74	20408-7	96	ESC-OR-22JM-CASE	71		
10207	12	10499	88	10967	41	36853	95	90408	36	92019	89	20415A	47	ESC-OR-24JM-CASE	71		
10209	12	10500	17	10970	42	36958	95	90409	36	92020	89	20429-10	96	ESC-OR-25T-CASE	71		
10211	13	10501	17	10971	42	40125	51	90410	36	92021	89	20429-14	96	ESC-OR-321T-CASE	71		
10212	13	10508	19	10972	42	40130	52	90411	37	92021	89	20429-8	96	ESC-OR-325T-CASE	71		
10220	9	10515	65	10973	42	40131	52	90412	37	92040	73	20462C	63	ESC-OR-329T-CASE	71		
10221	9	10522	65	10974	42	40132	52	90414	37	92041	73	20463C	63	ESC-OR-333T-CASE	71		
10222	10	10543	65	12105	67	40801	11	90415	37	92050	78	20464C	63	ESC-OR-335T-CASE	71		
10223	10	10590	19	12107	67	40802	11	90422	37	92051	78	20465C	63	ESC-OR-339T-CASE	71		
10240	14	10591	19	12109	67	40804	14	90423	38	92051	79	20466C	63	ESC-OR-343T-CASE	71		
10241	14	10592	18	12112	67	40805	14	90424	38	92052	78	20467C	63	ESC-OR-345T-CASE	71		
10242	14	10593	18	12113	67	40806	11	90425	38	92053	78	20468C	63	ESC-OR-349T-CASE	71		
10243	14	10594	19	12119	67	40807	69	90450	61	92055	79	20469C	63	ESC-OR-449T-CASE	71		
10245	11	10595	19	12122	67	41322	96	90451	61	92056	79	20470C	63	ESC-OR-451T-CASE	71		
10246	11	10600	23	12123	67	46271	96	90453	61	92057	79	306135L	95	ESC-OR-457T-CASE	71		
10247	11	10601	17	12500	32	50100	54	90455	61	92058	79	36853L	95	ESC-OR-463T-CASE	71		
10300	21	10603	23		68	50103	54	90456	62	202636	95	40125-100	51	ESJ-100-27	28		
10301	20	10604	23	12501	32	50114	54	90520	77	202636	95	40125-T	51	ESJ-100-38	28		
10302	20	10605	23		68	50117	54	90521	77	204238	95	40802-6A	11	ESJ-150-27	28		
10303	20	10606	23	12502	32	50121	54	90530	75	204238	95	40802-6B	11	ESJ-150-38	28		
10304	20	10607	12		68	50122	56	90531	75	300444	95	40802-6C	11	ESJ-200-27	28		
10305	20	10610	23	12503	32	50128	55	90534	75	300831	96	40802-6D	11	ESJ-200-38	28		
10306	20	10611	23		68	50147	56	90535	76	302651	95	40802S	11	ESJ-250-27	28		
10308	21	10620	8	12545	33	50301	58	90538	72	306135	95	40804-VA	14	ESJ-250-38	28		
10312	21	10625	23	12546	33	50303	58	90555	76	420438	95	420438L	95	ESJ-300-27	28		
10313	95	10626	23	12549	34	60100	58	90572	76	10000-C	6	50128-1	55	ESJ-300-33	28		
10314	21	10627	13	12555	34	60101	58	90573	76	10000-E	6	50128-2	55	ESJ-350-27	28		
10315	20	10701	95	12556	34	60102	58	91000	25	10000-F	6	50128-3	55	ESJ-350-33	28		
10320	24	10701	95	12581	34	60104	58	91001	25	10007-EXT	50	50128-5	55	G382107	95		
10321	24	10751	32	12582	34	60105	58	91003	26	10010-EXT	50	50128-KIT	55	G385044	95		
10322	24	10752	32	12583	34	60106	58	91004	26	10100RK	95	58449YE3	95	LA206A	96		
10323	24	10753	32	12585	34	60107	58	91005	26	10103-3	95	70162K	70	LA213	96		
10324	24	10754	32	12586	34	60108	58	91006	27	10103L	13	90456S	62	LA213	96		
10340	24	10755	32	12587	34	60109	58	91008	27	10312-15	96	90518-100-1	44	PAT1102K1	96		
10341	24	10802	90	20100	35	60202	57	91015	27	10312-RK	96	90518-100-KIT	44	RC102K	95		
10342	24	10803	90	20101	35	60203	57	91016	27	10312-VP	96	90518-200-1	44	RC-102K	95		
10343	24	10804	90	20200	35	60300	59	91017	27	10435-RKB	96	90518-200-KIT	44	RC2510K	95		
10344	24	10805	90	20202	35	60301	59	91021	27	10438-RK	96	90518-200M	45	RCA502K	95		
10345	24	10808	22	20204	35	60302	59	91022	27	10446-28	96	B1069028	95	RCS302K	95		
10346	24	10809	22	20390	35	60303	59	91026	27	10446-AMK	96	B1069028	95	RED-70208-2	96		
10347	24	10812	80	20391	35	60305	50	91027	27	10446-CK	96	B1139028	95	TO-100-14	95		



ESCO

www.esco.net

AUTOMOTIVE

HEAVY-DUTY TRUCK

MINING

OFF-THE-ROAD

SERVICE TRUCKS

AGRICULTURAL

INDUSTRIAL

AND MORE...

DISTRIBUTED BY:



ESC-CAT-34
PRINTED IN THE USA



15270 Flight Path Drive
Brooksville, FL 34604

Toll Free 1.800.352.9852 (U.S & Canada Only)

Phone: 352.754.1117 Fax: 352.754.4508

Email: sales@esco.net Website: www.esco.net

